

**A**

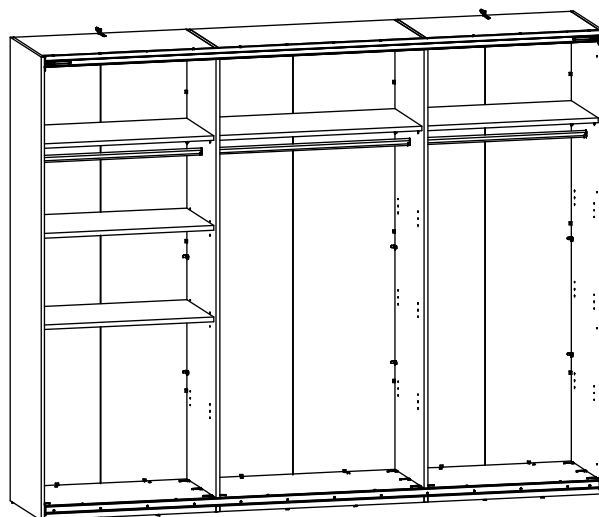

**B**

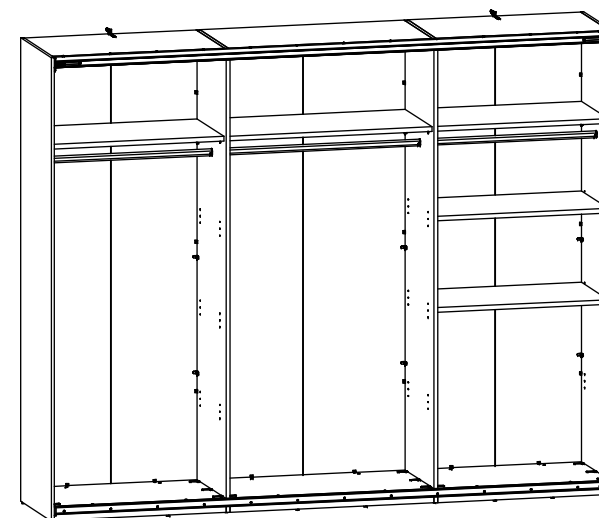

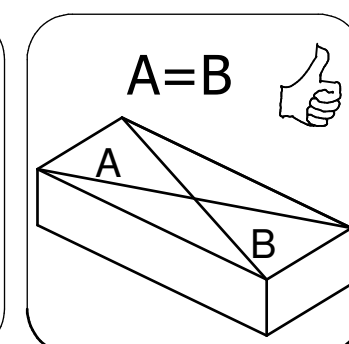
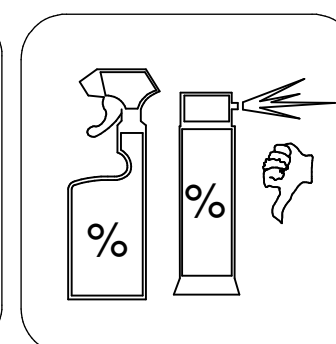
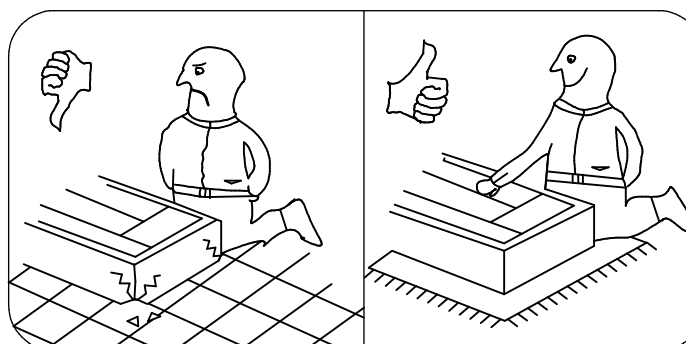
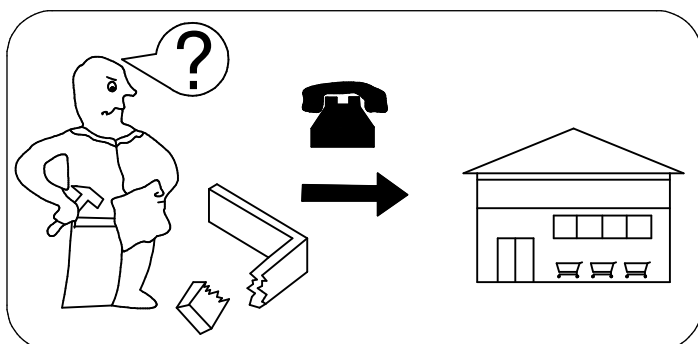
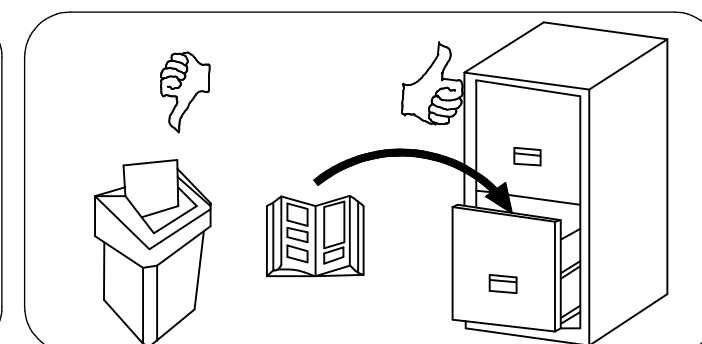
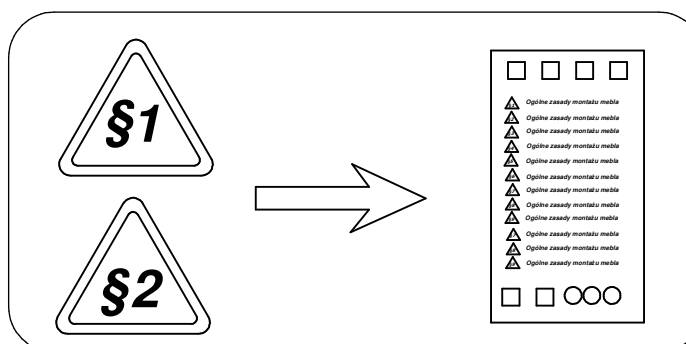
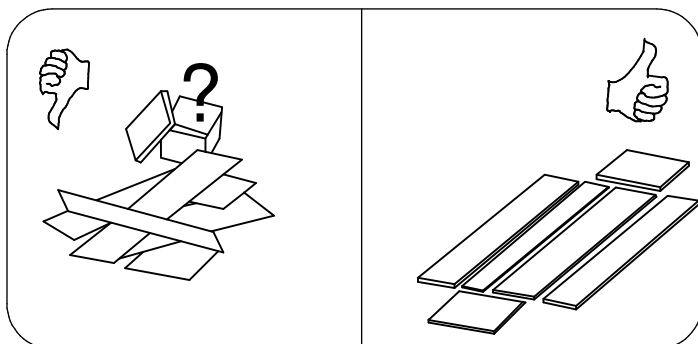
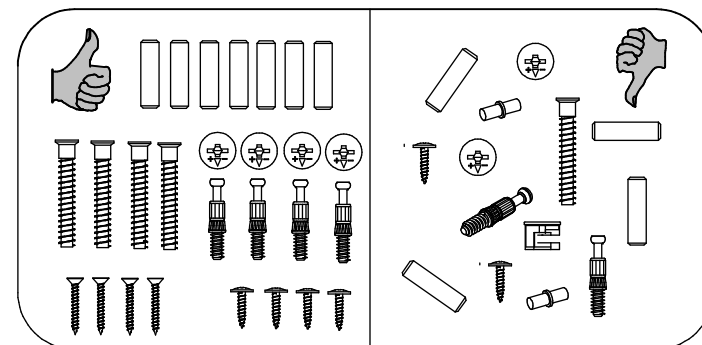
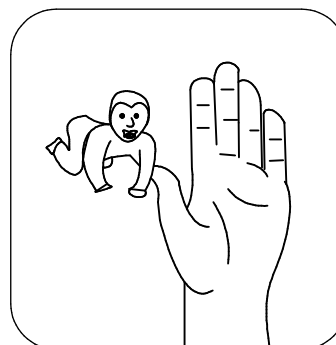
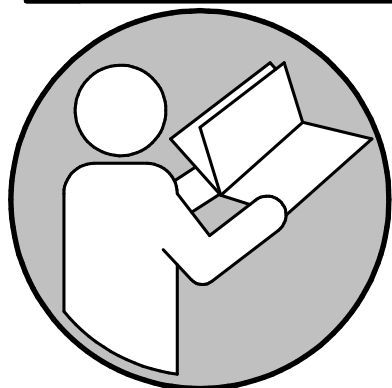

<b>B1</b>	<b>B2</b>	<b>C1</b>	<b>C2</b>	<b>C3</b>	<b>C4</b>	<b>D</b>
L153-3009	-.1	826	480	22	4	1/1

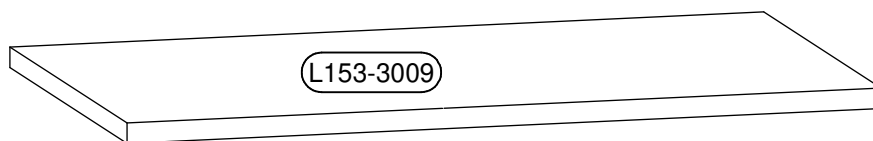
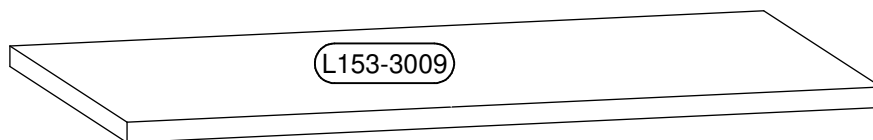

1:1

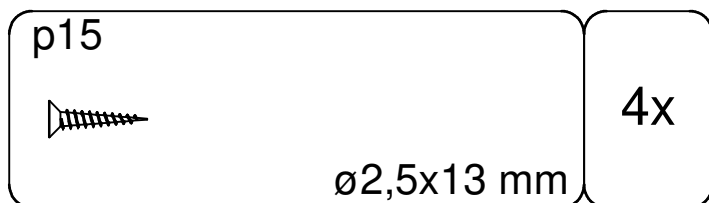
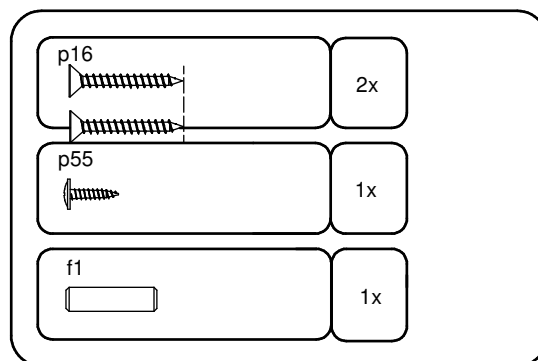
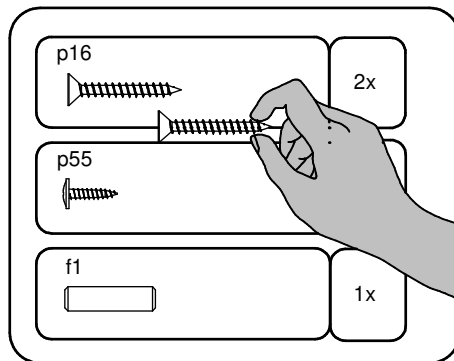



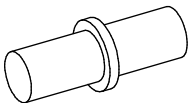
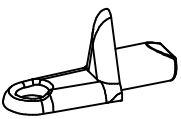

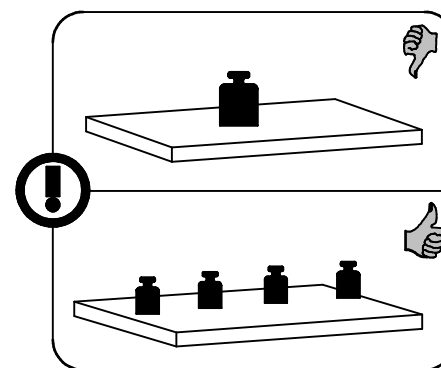
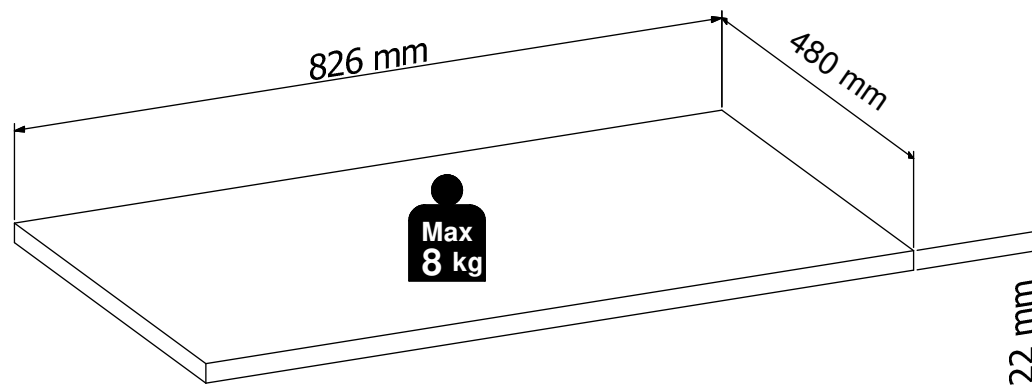



~~1:1~~

d1  fi5mm	4x	d39 	4x
--	----	---	----

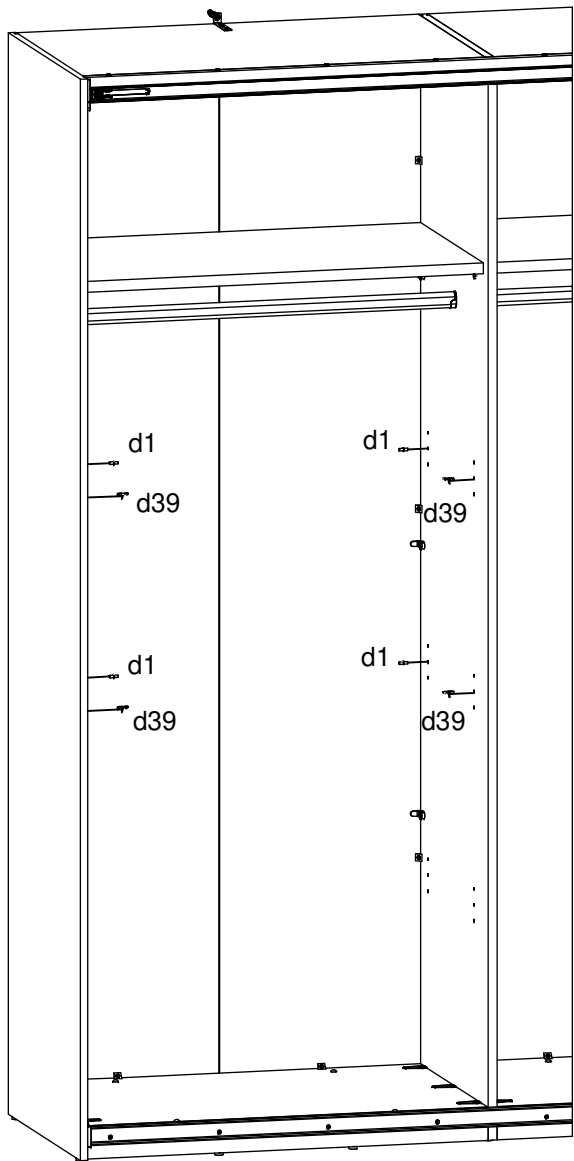





# 1A

d1		4x	d39		4x
	fi5mm				







d1



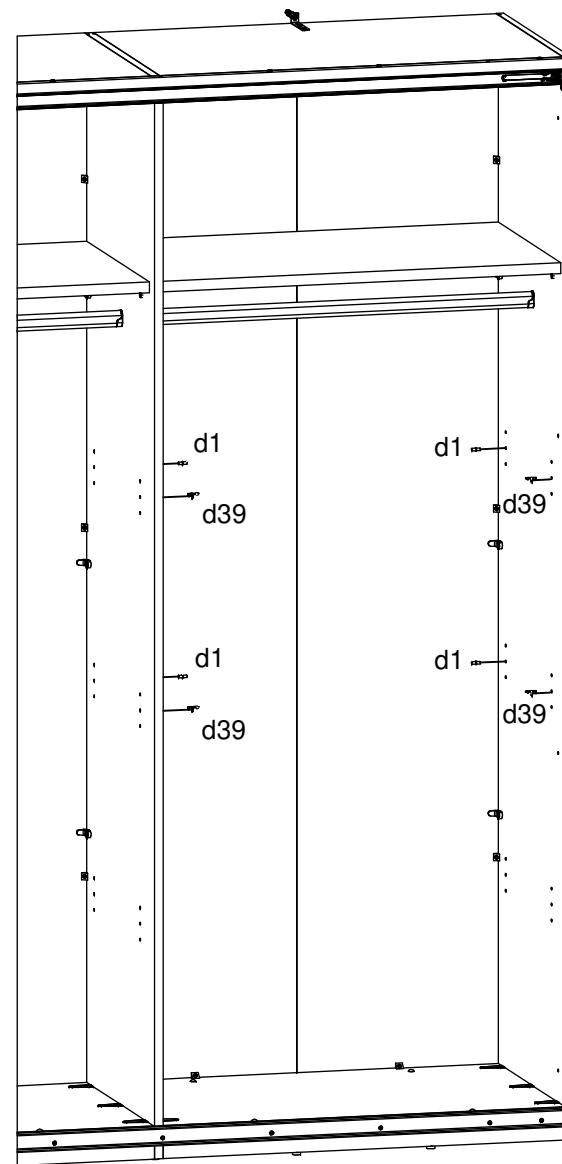
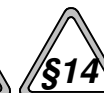

d39

# 1B

d1		4x	d39		4x
	fi5mm				

d1

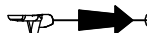
d39

A

L153-POL/83

HENSON

8 / 8

2A

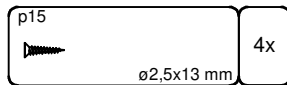

2B

