

	B1	B2	C1	C2	C3	C4	D
L153-1010	-.3	2000	300	22	1	3/4	
L153-1011	-.3	2000	300	22	1	3/4	
L153-4007	-.1	1646	305	22	1	2/4	
L153-4008	-.3	250	100	15	2	3/4	
L153-4009	-.3	1734	261	16	2	3/4	
L153-4010	-.3	145	100	15	2	3/4	
L153-4011	-.3	1650	950	36	1	1/4	
L153-4014	-.3	1600	261	16	1	2/4	
L153-5002	-.1	1650	410	76	1	4/4	
L153-9004	-.2	1732	638	6	2	1/4	

1:1

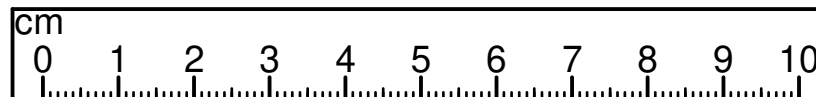
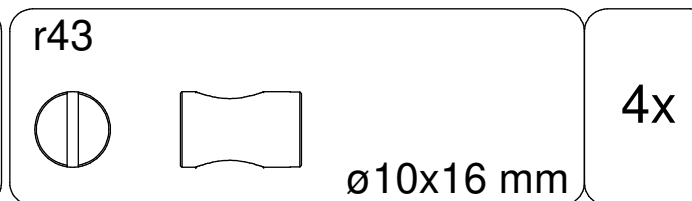
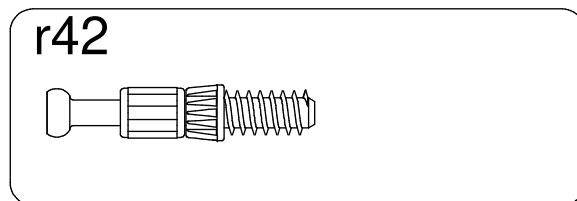
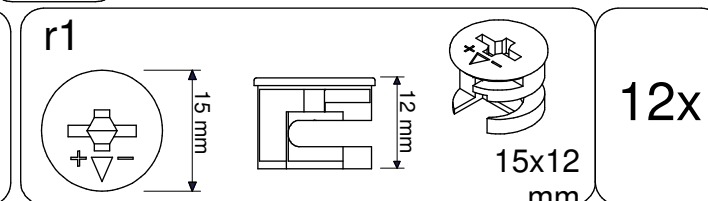
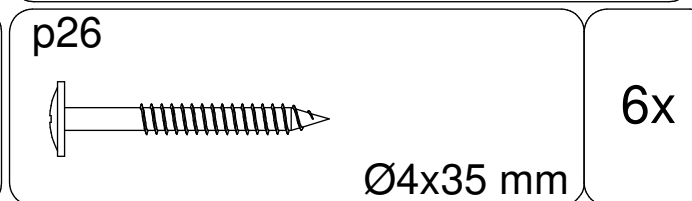
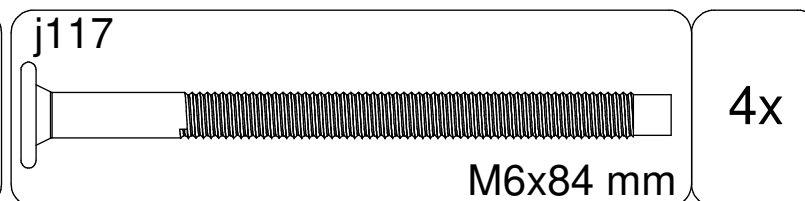
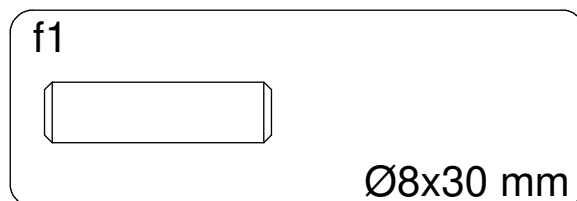
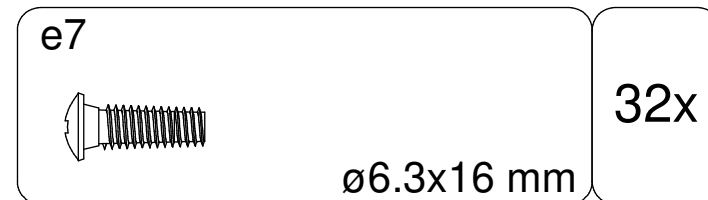
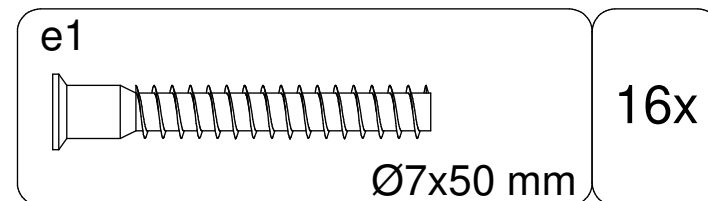
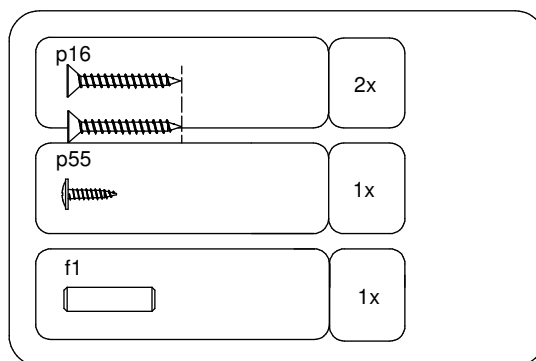
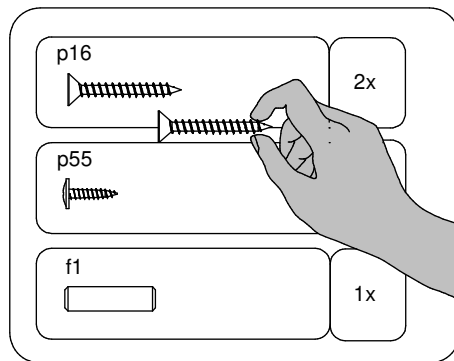

~~1:1~~

k103

 $\varnothing 20 \times 3,5 \text{ mm}$

13x

n63

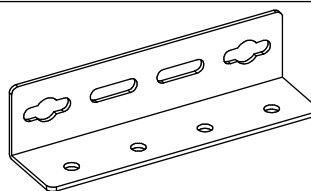

2x

n231\L

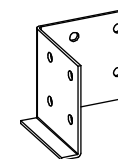

1x

n231\P

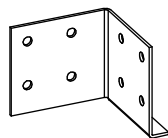

1x

z1

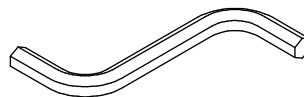

1x

 4 mm

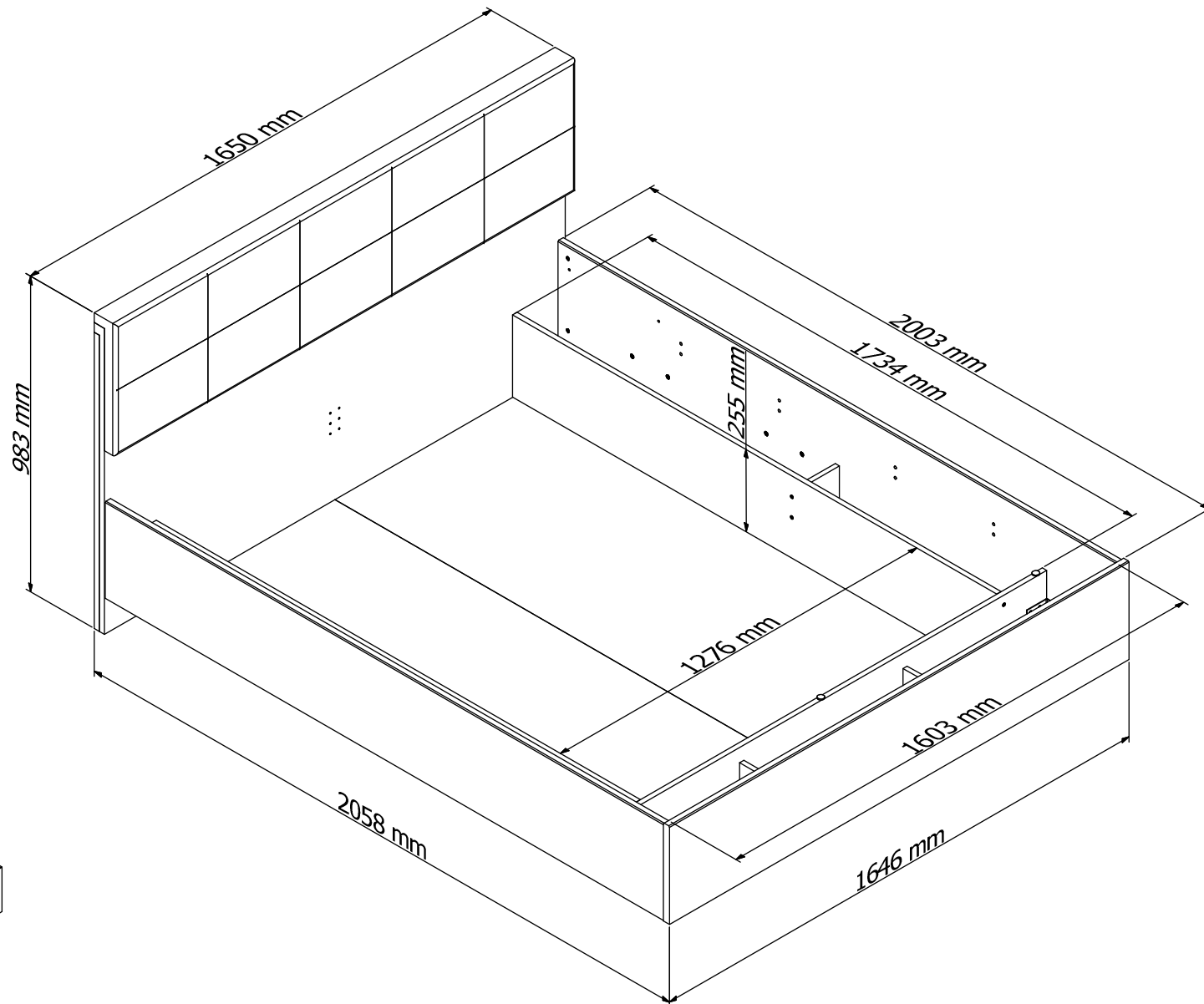
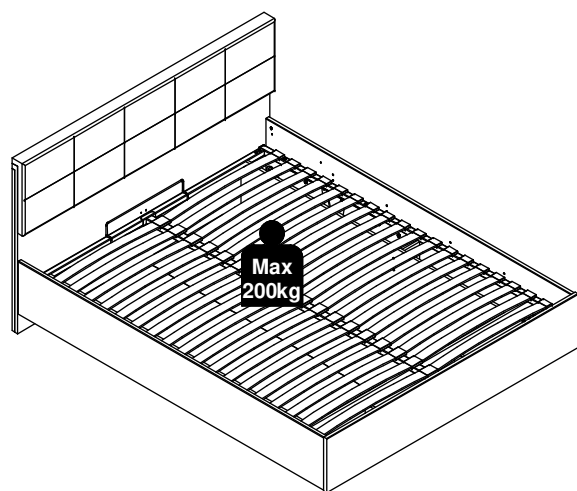
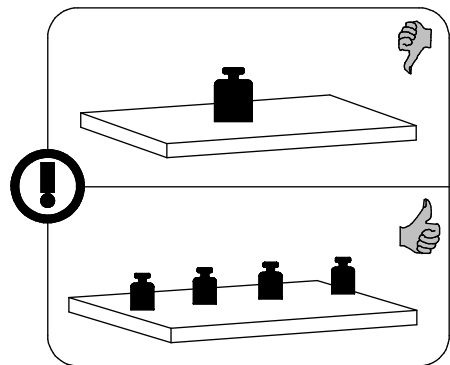

- 1** e7 8x $\varnothing 6.3 \times 16 \text{ mm}$
- f1 4x $\varnothing 8 \times 30 \text{ mm}$
- n63 2x
- n231\L 1x
- n231\P 1x
- r1 4x
- r42 8x

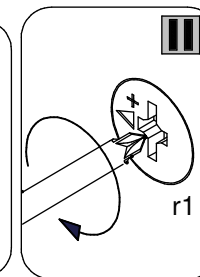
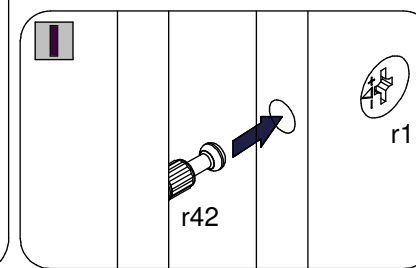
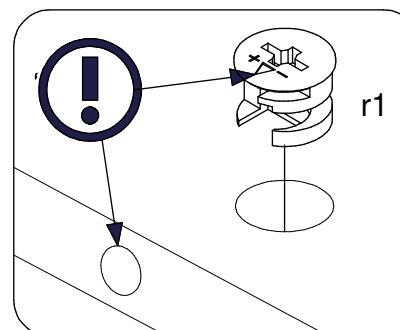
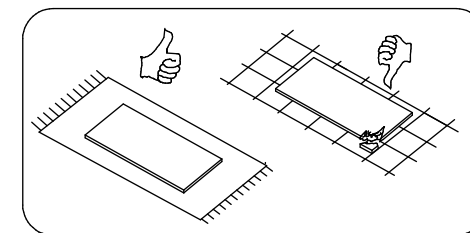
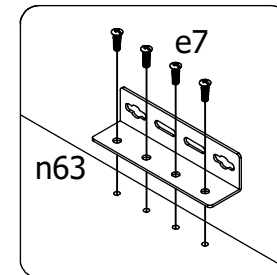
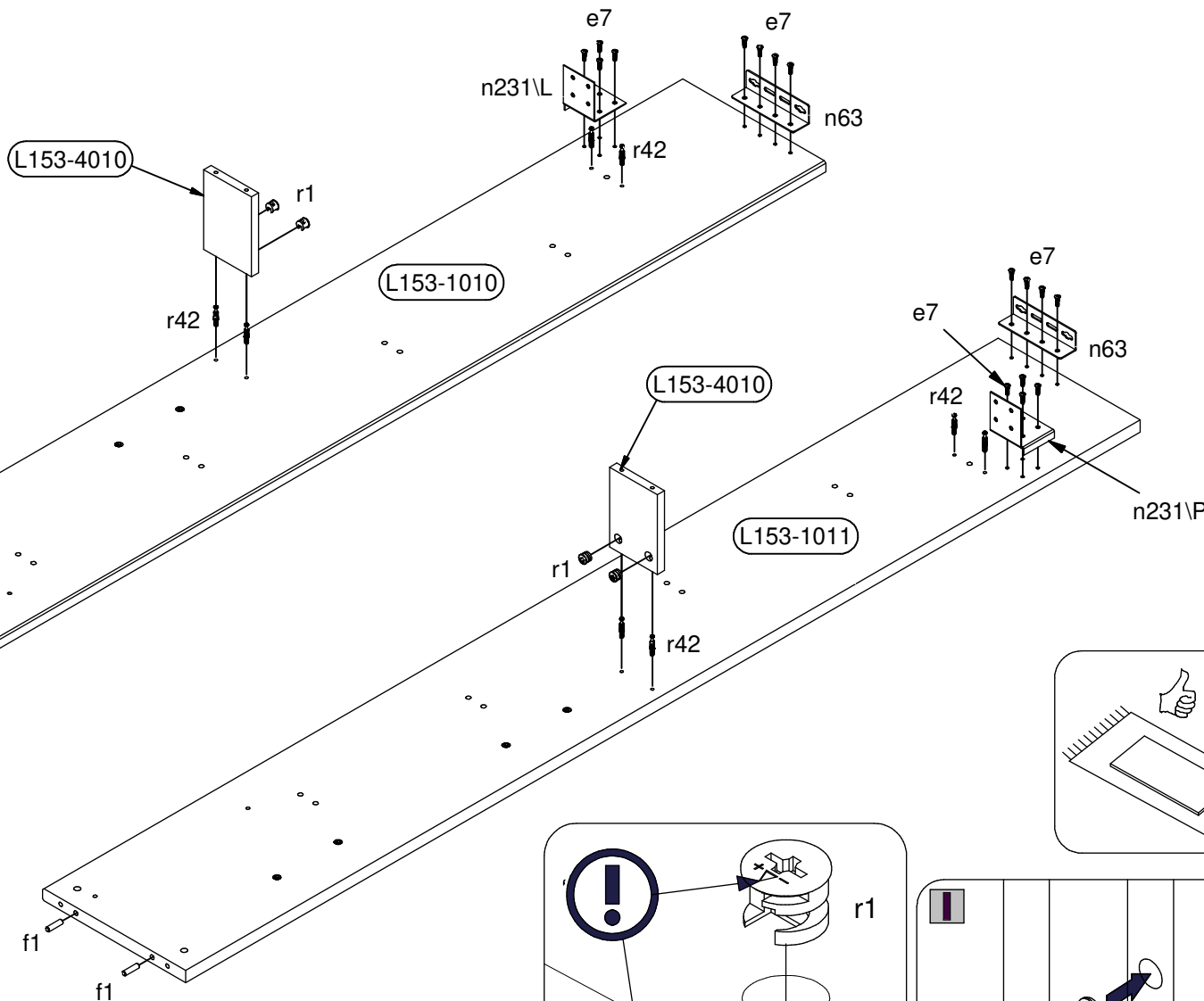
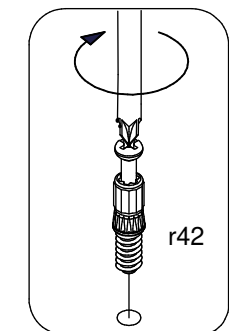
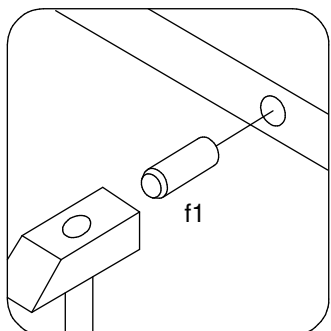

2



4x

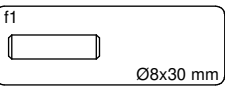

2x

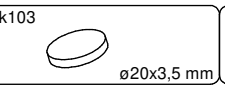

6x

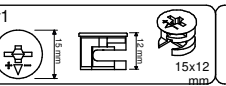

8x

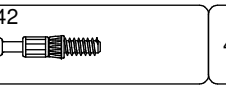

4x

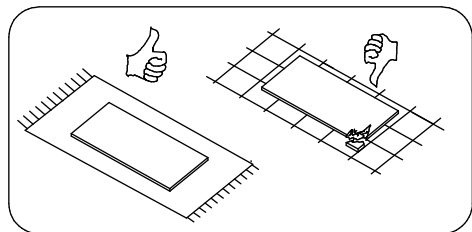
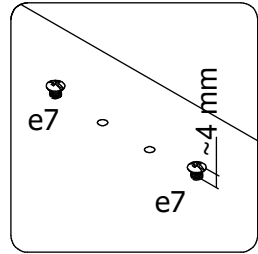
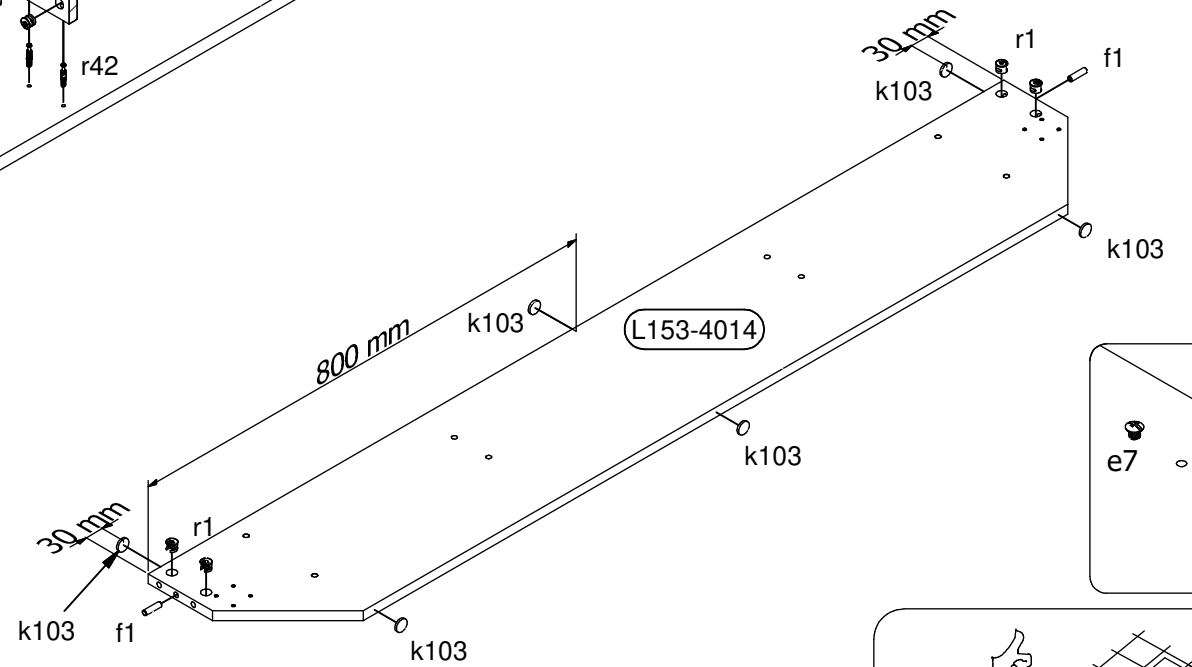
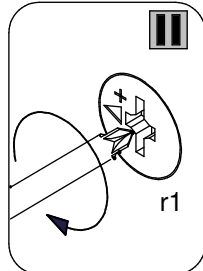
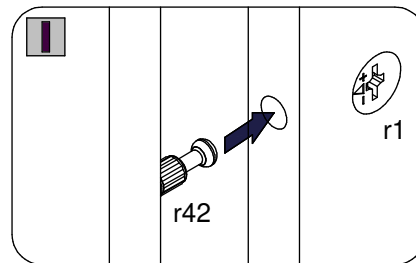
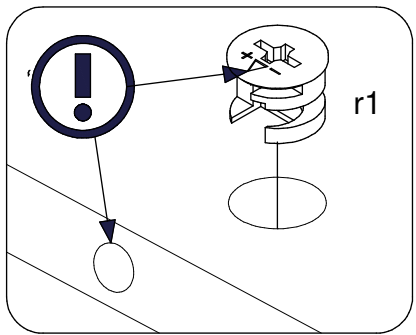
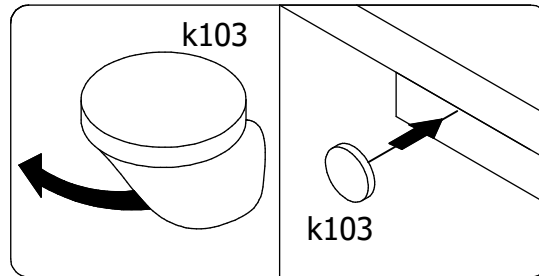
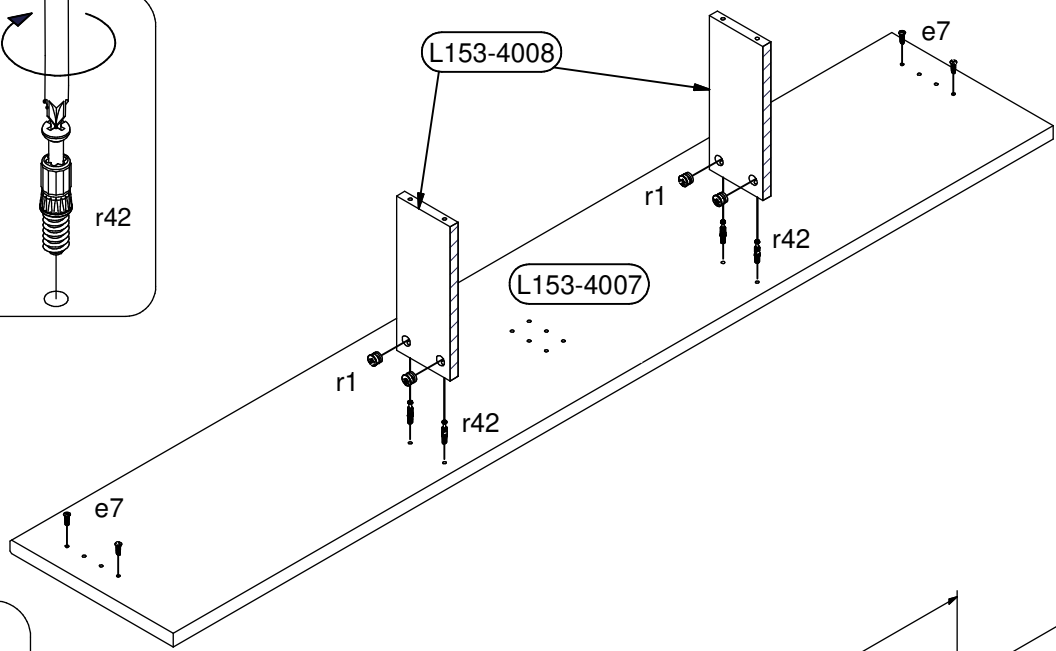
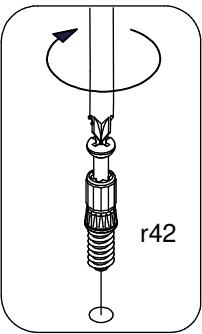
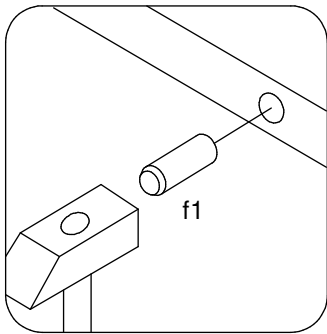

3

k103



ø20x3,5 mm

7x

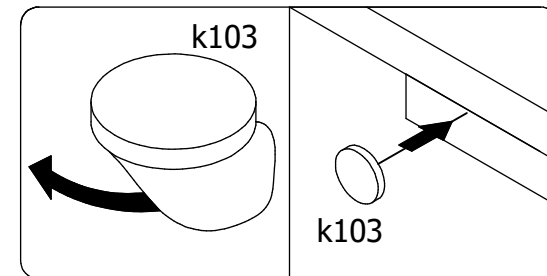
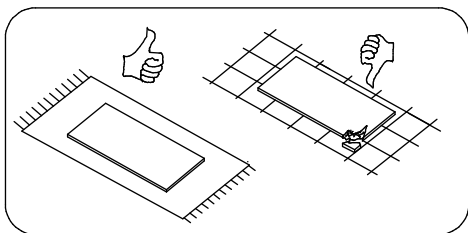
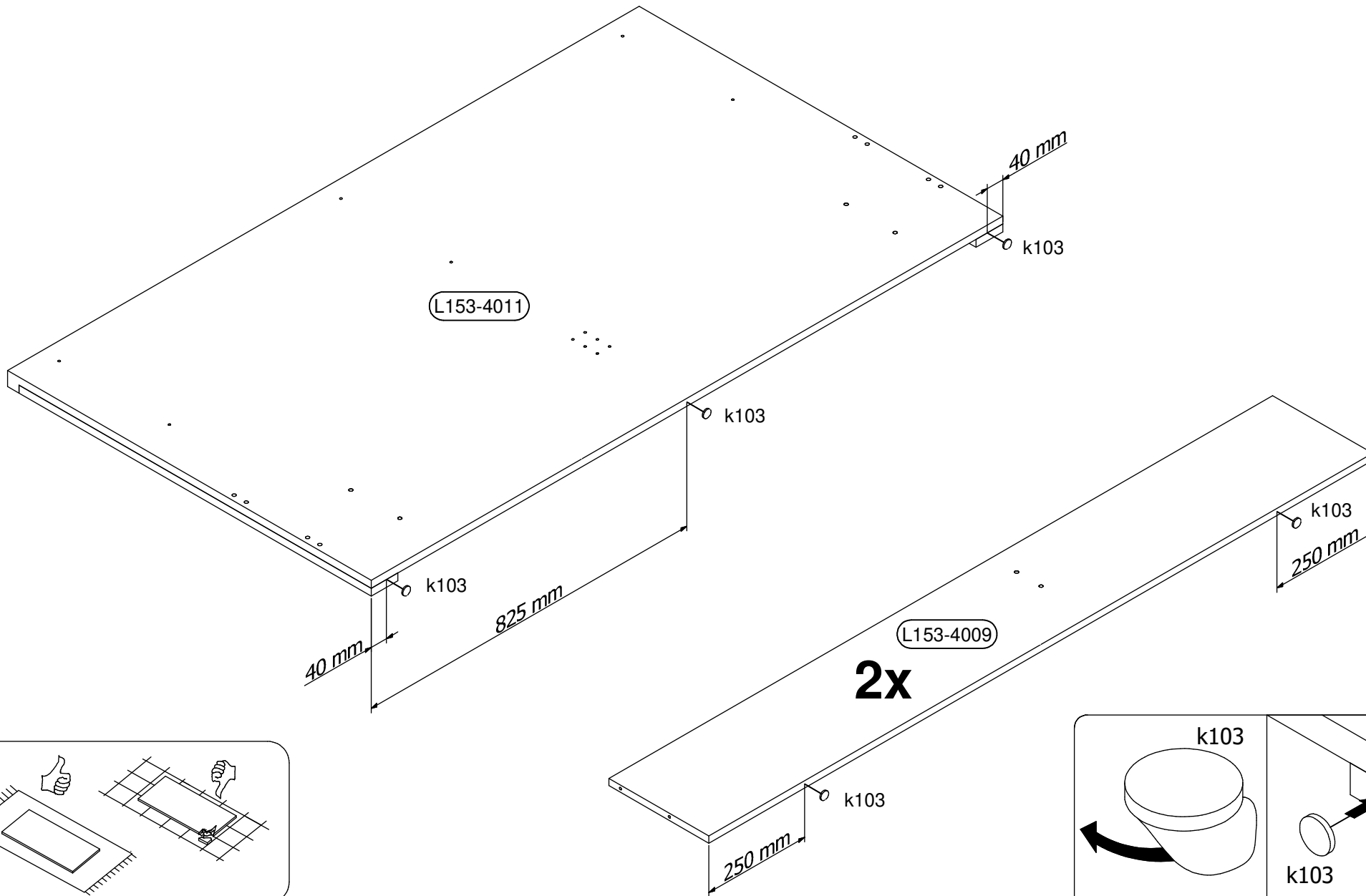

4

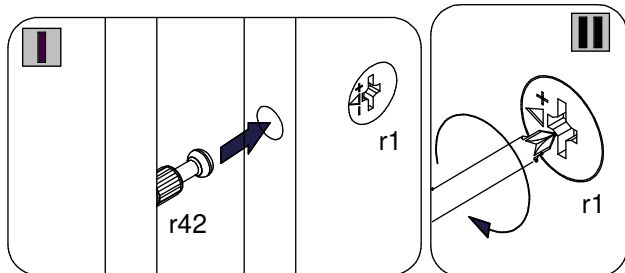
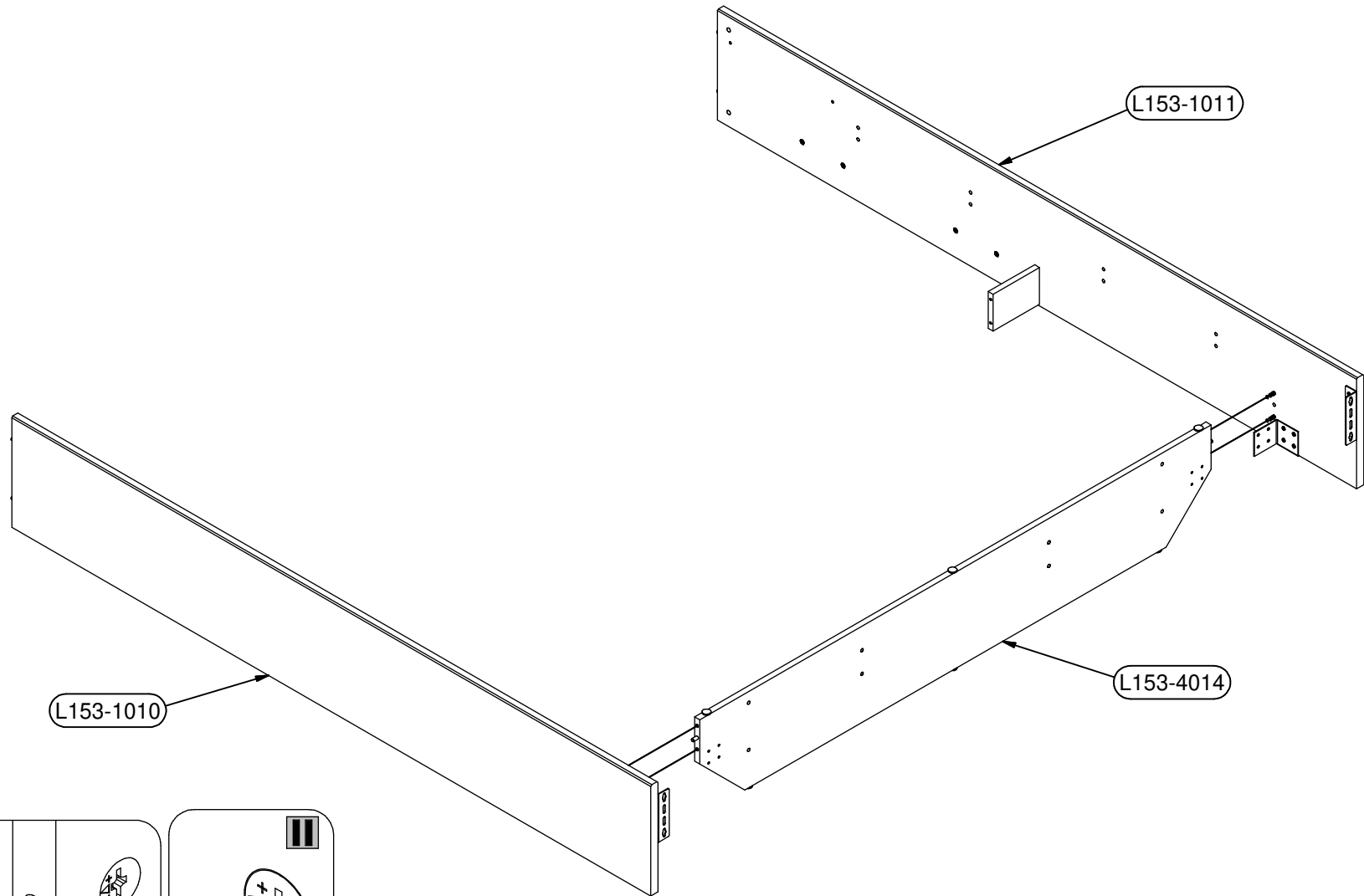

5

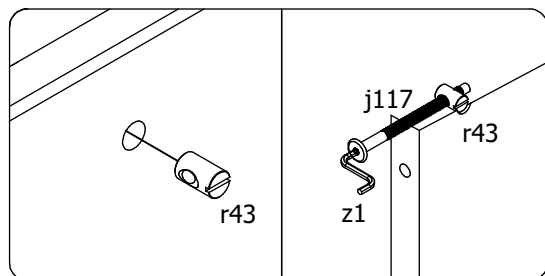
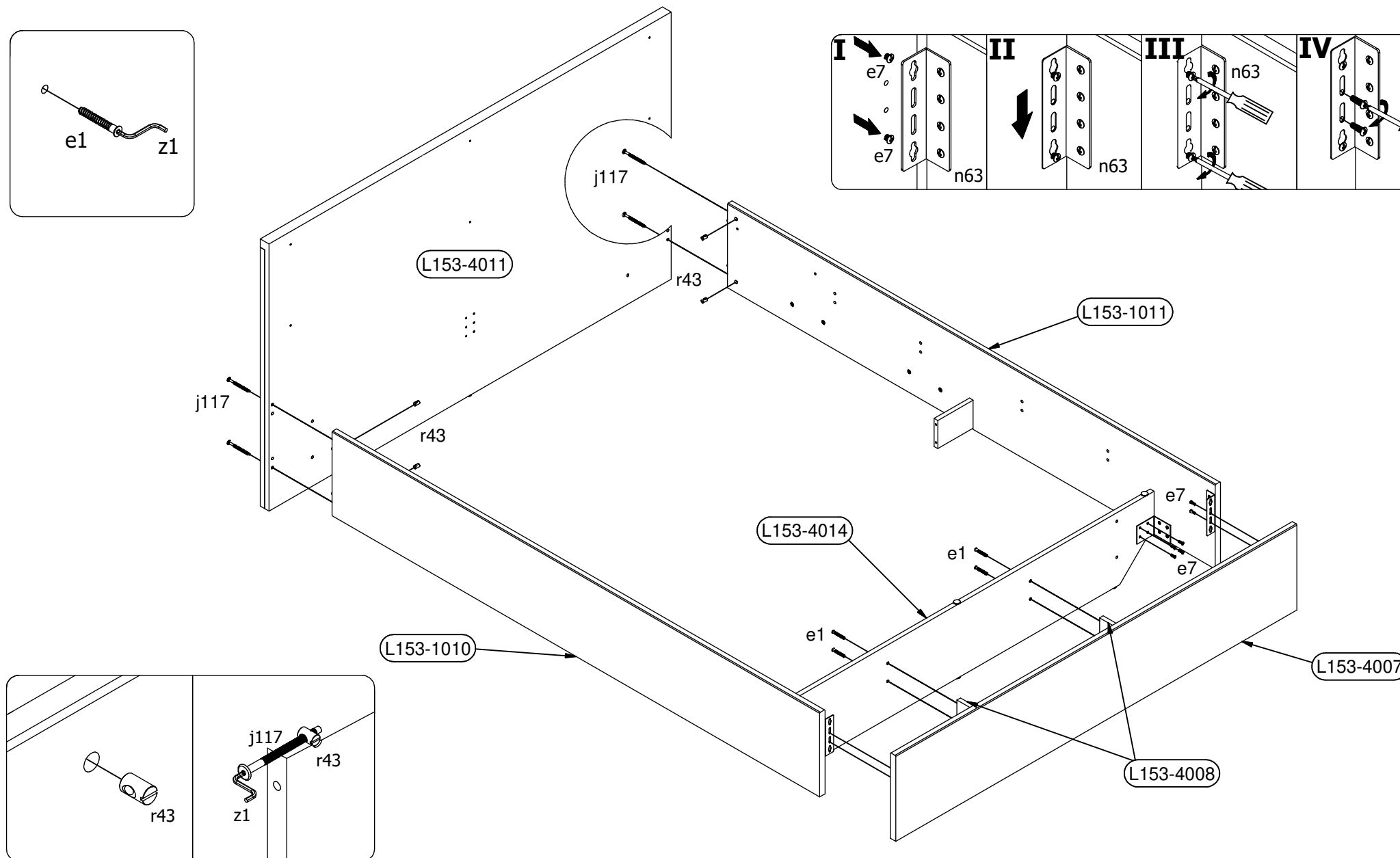
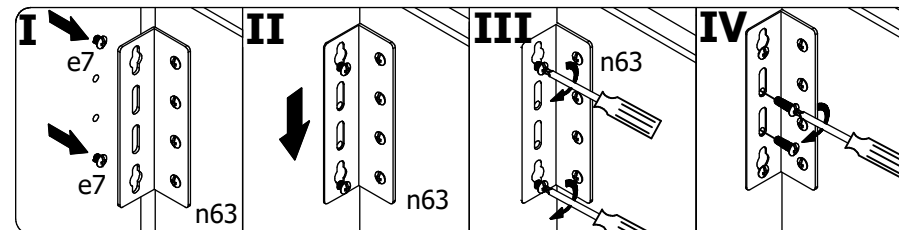
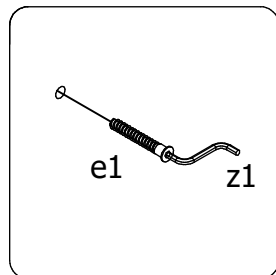
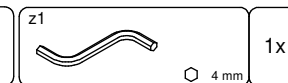
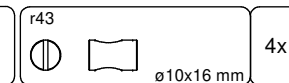
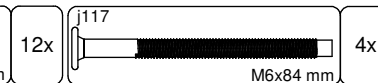
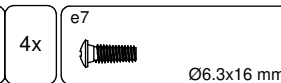
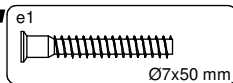

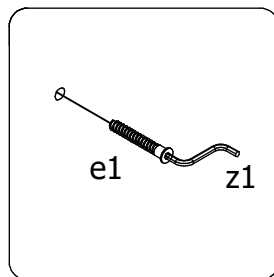
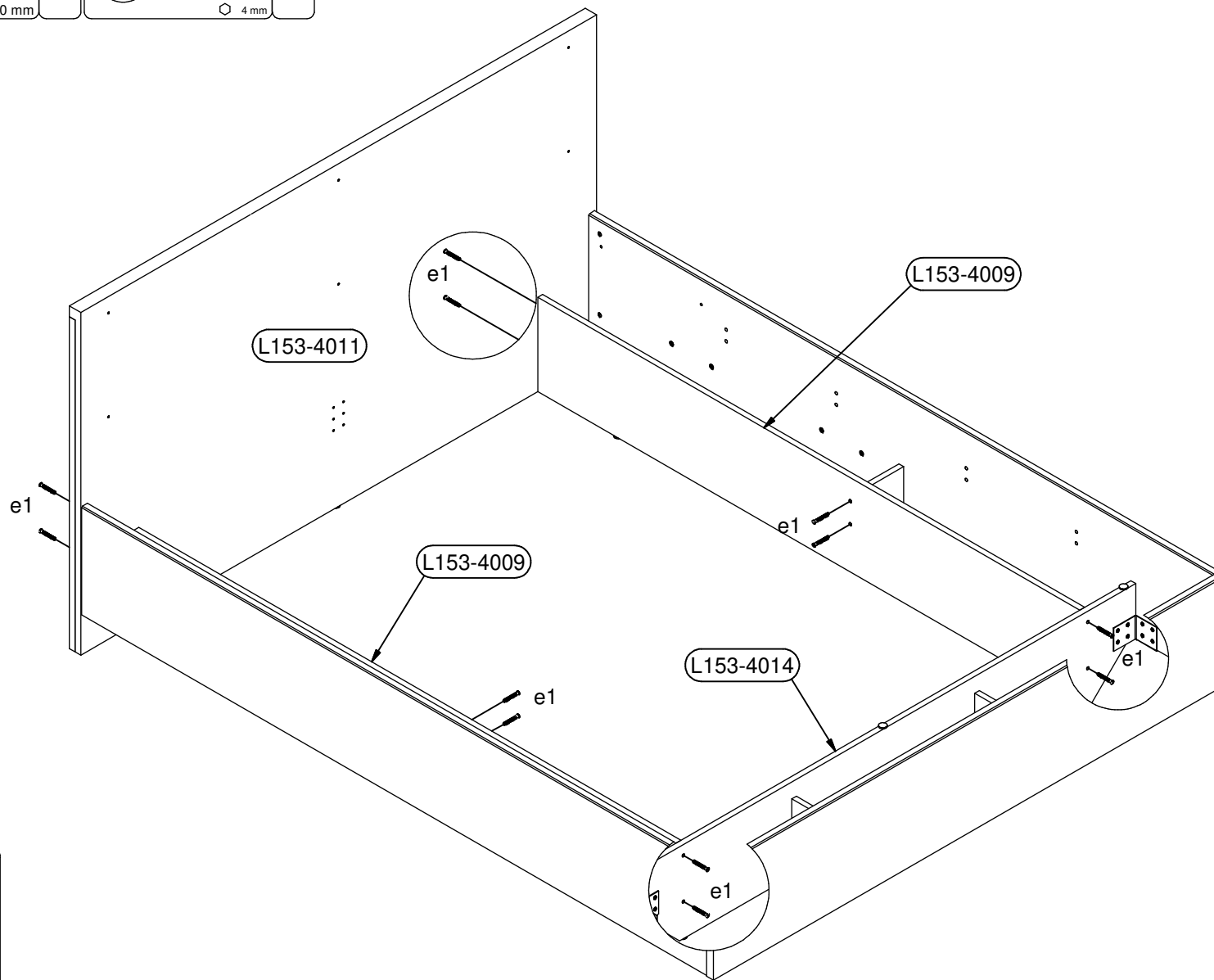
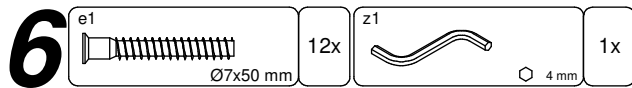

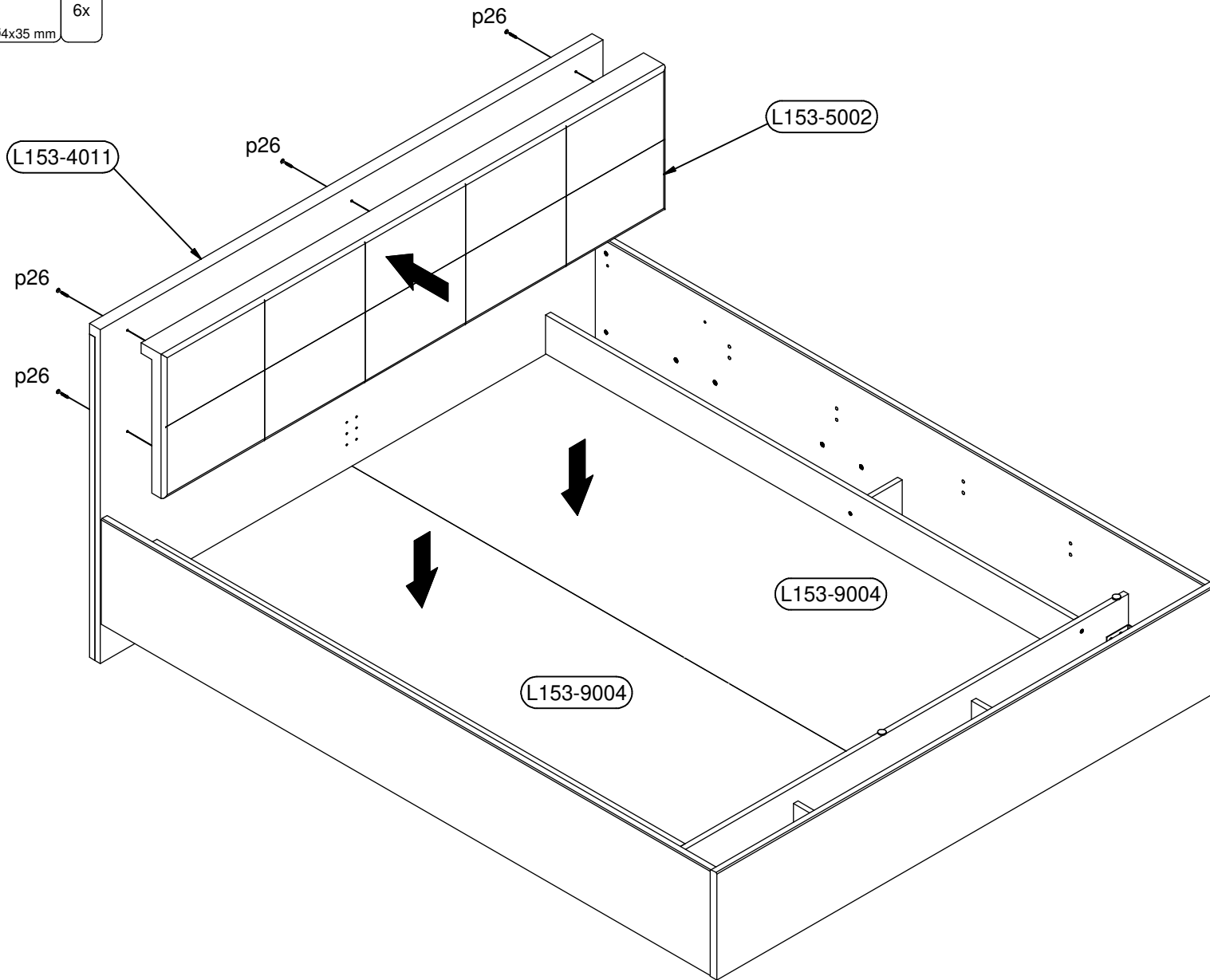
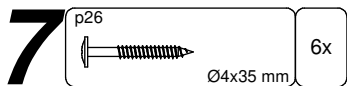

8

8x

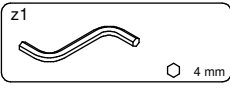

1x

