

	B1	B2	C1	C2	C3	C4	D
dr-468	-	468	22	15	2	1/3	
S659-0005	-	1114	369	15	1	3/3	
S659-0006	-	738	369	15	1	3/3	
S659-0007	-	1856	468	15	1	3/3	
S659-1010	-	1864	556	15	1	2/3	
S659-1011	-	1864	556	15	1	2/3	
S659-1012	-	1864	536	15	1	3/3	
S659-2007	-	900	560	22	1	1/3	
S659-2008	-	900	560	15	1	1/3	
S659-3009	-	377	518	15	1	1/3	
S659-3010	-	476	518	15	1	1/3	
S659-3011	-	376	510	15	5	1/3	
S659-9004	-	1874	389	2,5	1	2/3	
S659-9303	-	1874	489	2,5	1	2/3	

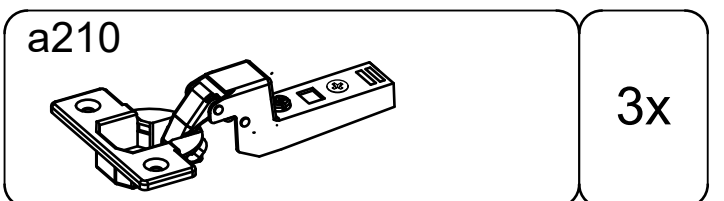

1:1

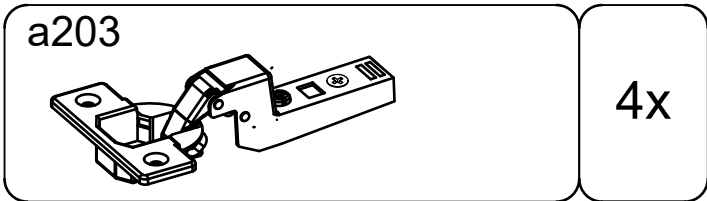
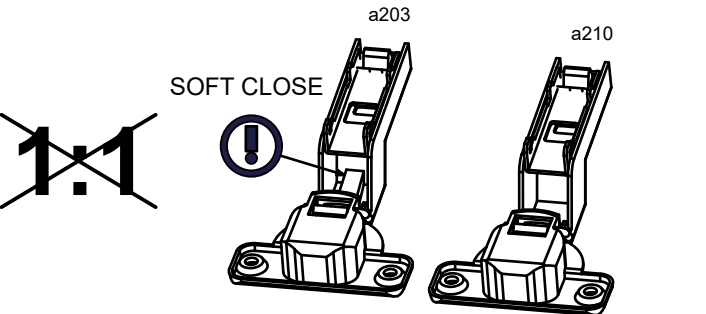
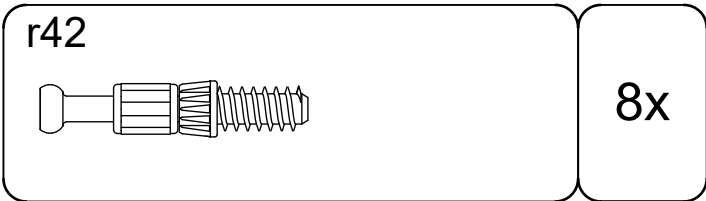
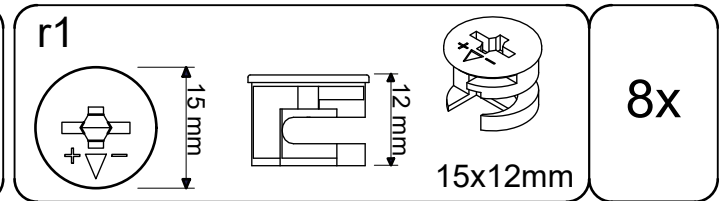
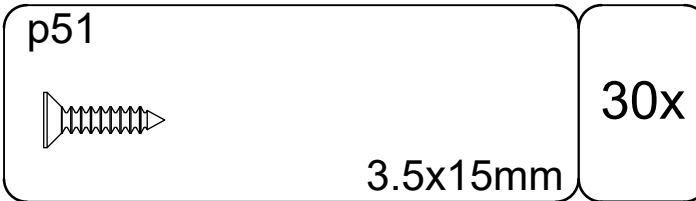
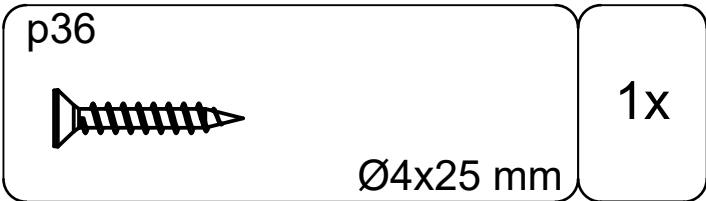
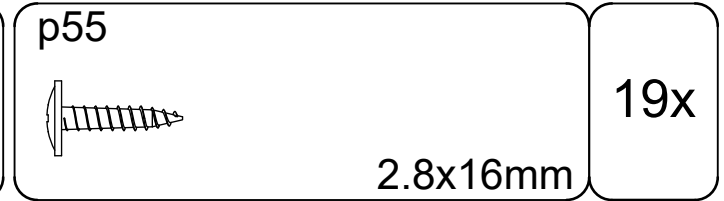
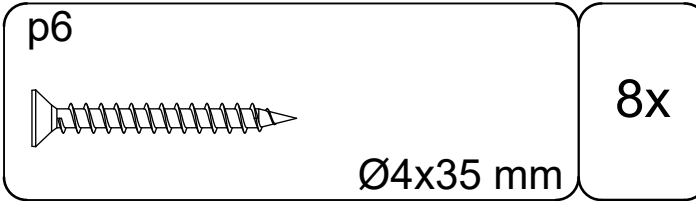
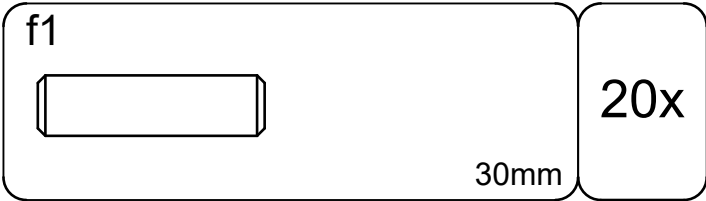
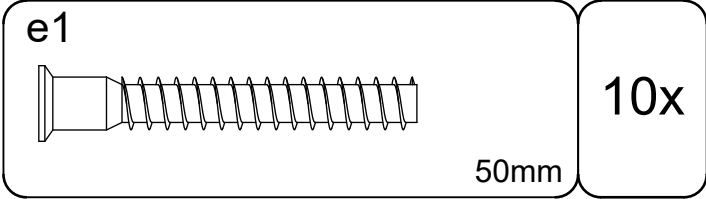
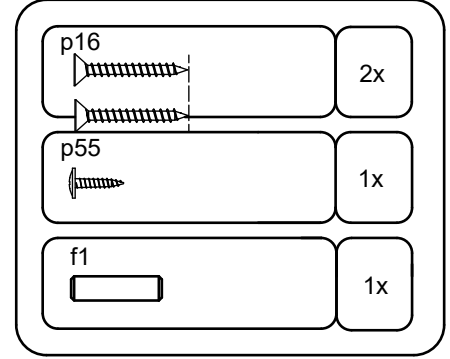
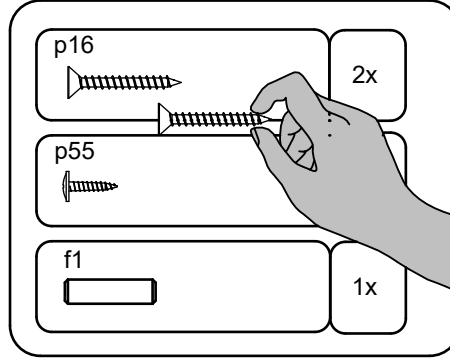
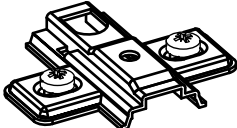
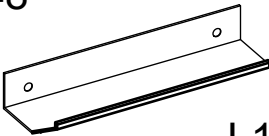

b90		7x	c648		2x
				L149/128mm	

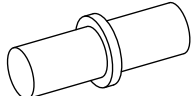
d1		20x
	fi5mm	

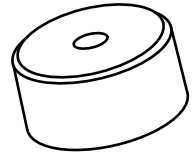
k53		1x
-----	--	----

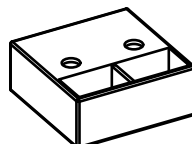
k55		4x
-----	---	----

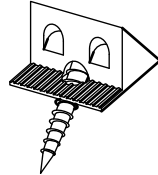
l2		14x
----	---	-----

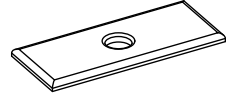
n108		13x
------	--	-----

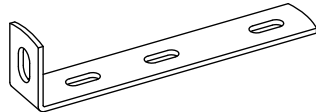
n14\2		1x
-------	---	----

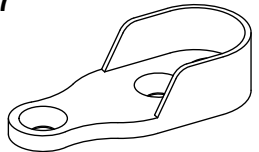
n267		4x
------	--	----

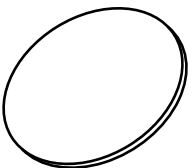

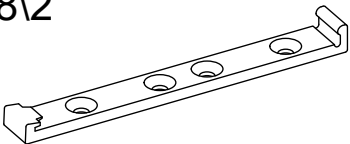
s68		4x
	Ø20mm	

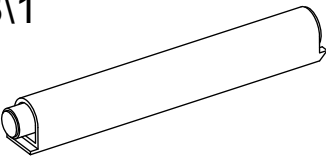
z28\2		1x
-------	--	----

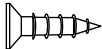
z28\1		1x
-------	---	----

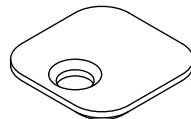
z28\4		3x
	3x12mm	

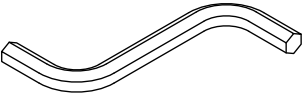
z28\3		1x
-------	---	----

z1		1x
	 4mm	

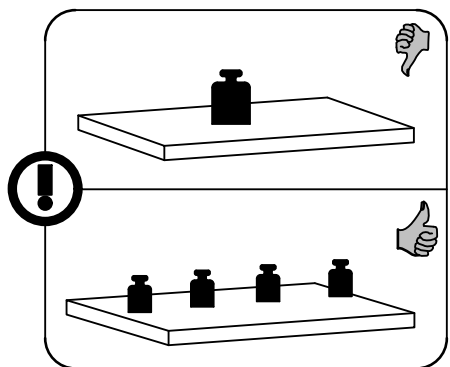
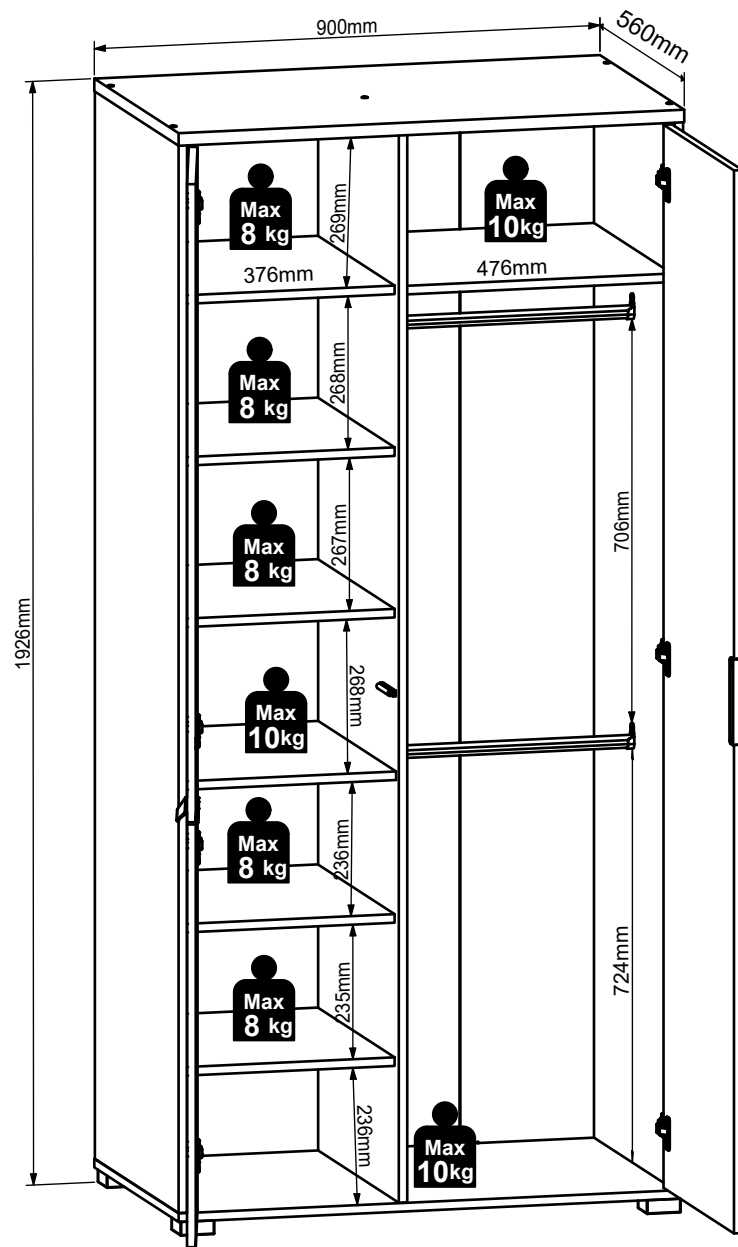



<p>b90</p>	<p>4x</p>	<p>d1</p>	<p>10x</p>	<p>r42</p>	<p>2x</p>	<p>f1</p>	<p>30mm</p>	<p>4x</p>
------------	-----------	-----------	------------	------------	-----------	-----------	-------------	-----------

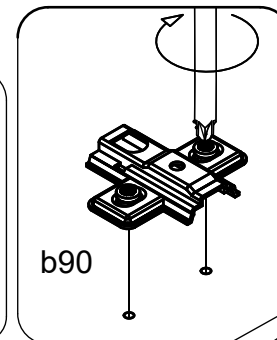
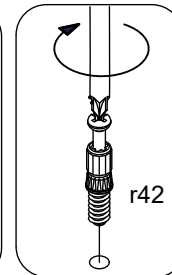
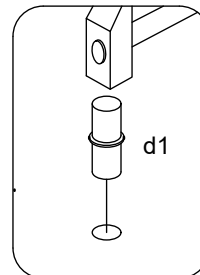
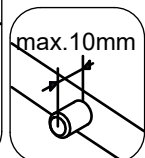
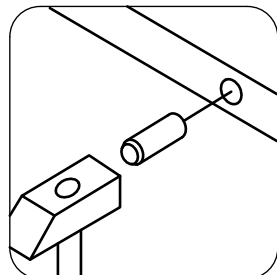
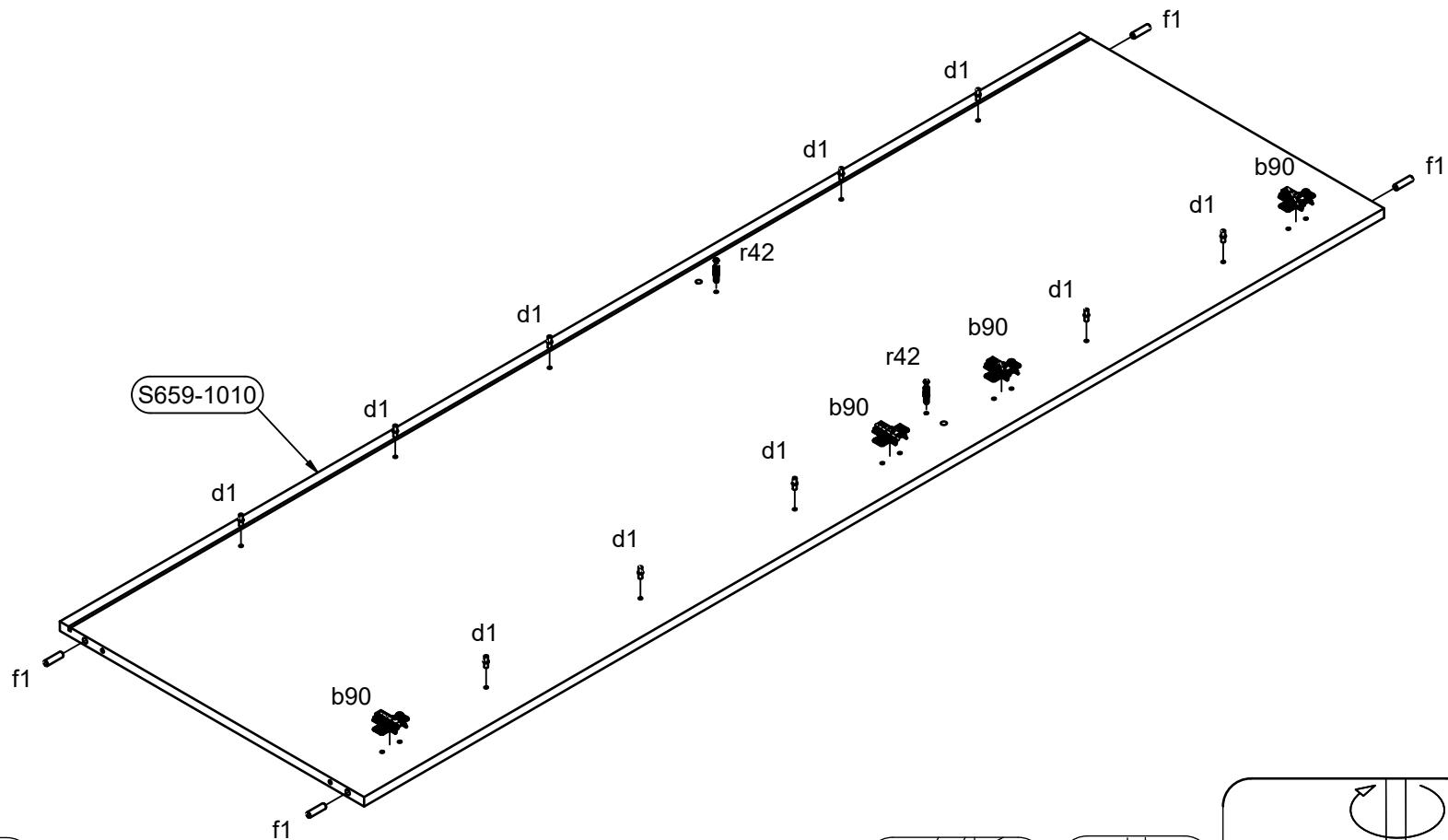

2

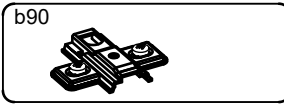

3x



2x

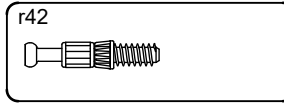

2x

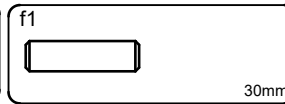

4x

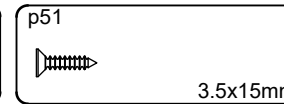

4x

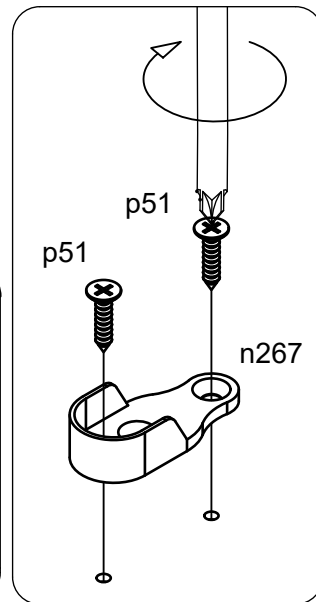
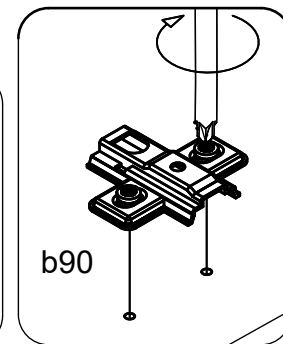
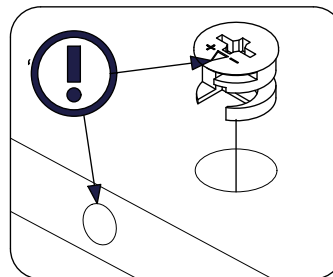
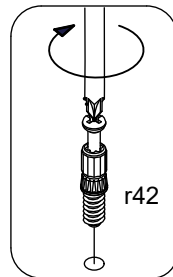
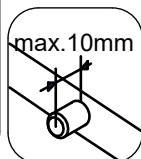
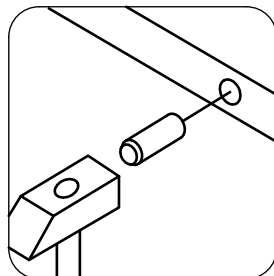
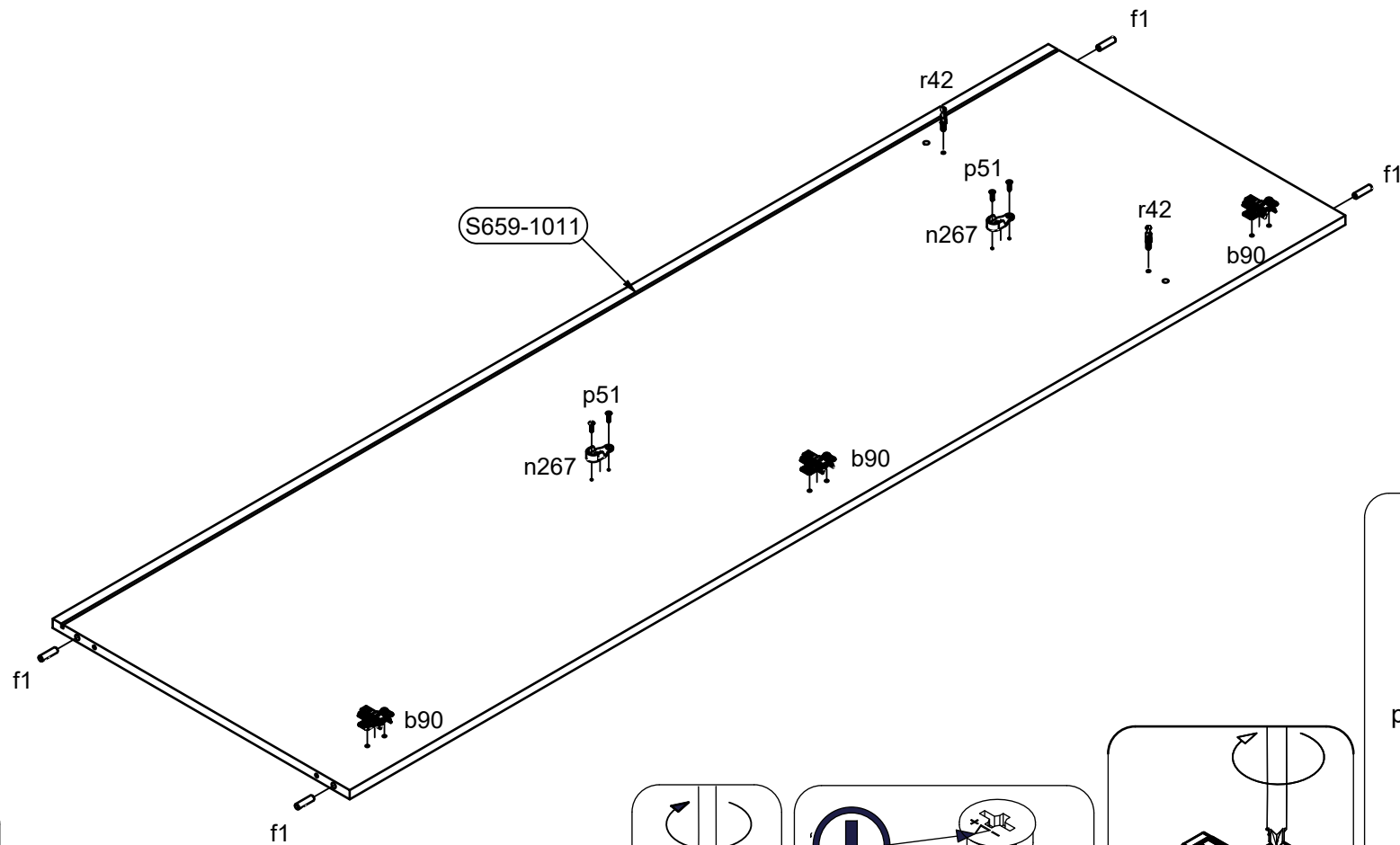

3

d1 10x fi5mm

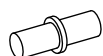

n267 2x



r42 4x



f1 4x 30mm

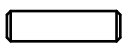



p51 4x 3.5x15mm

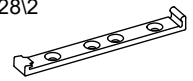

z28\2 1x

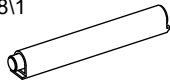

z28\1 1x

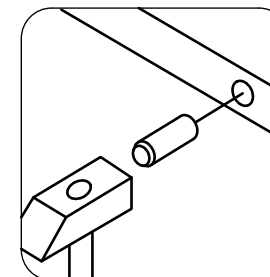
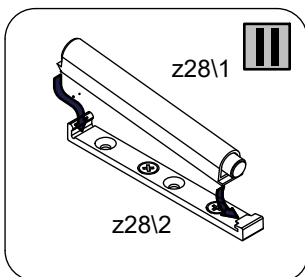
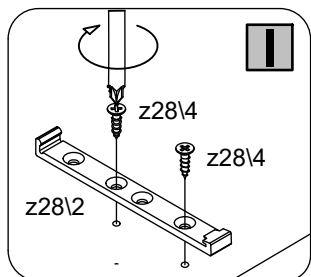
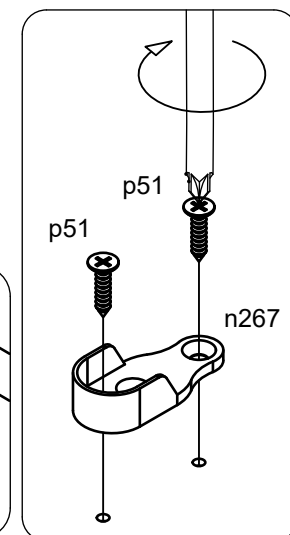
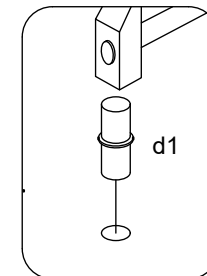
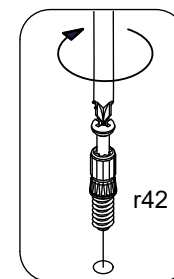
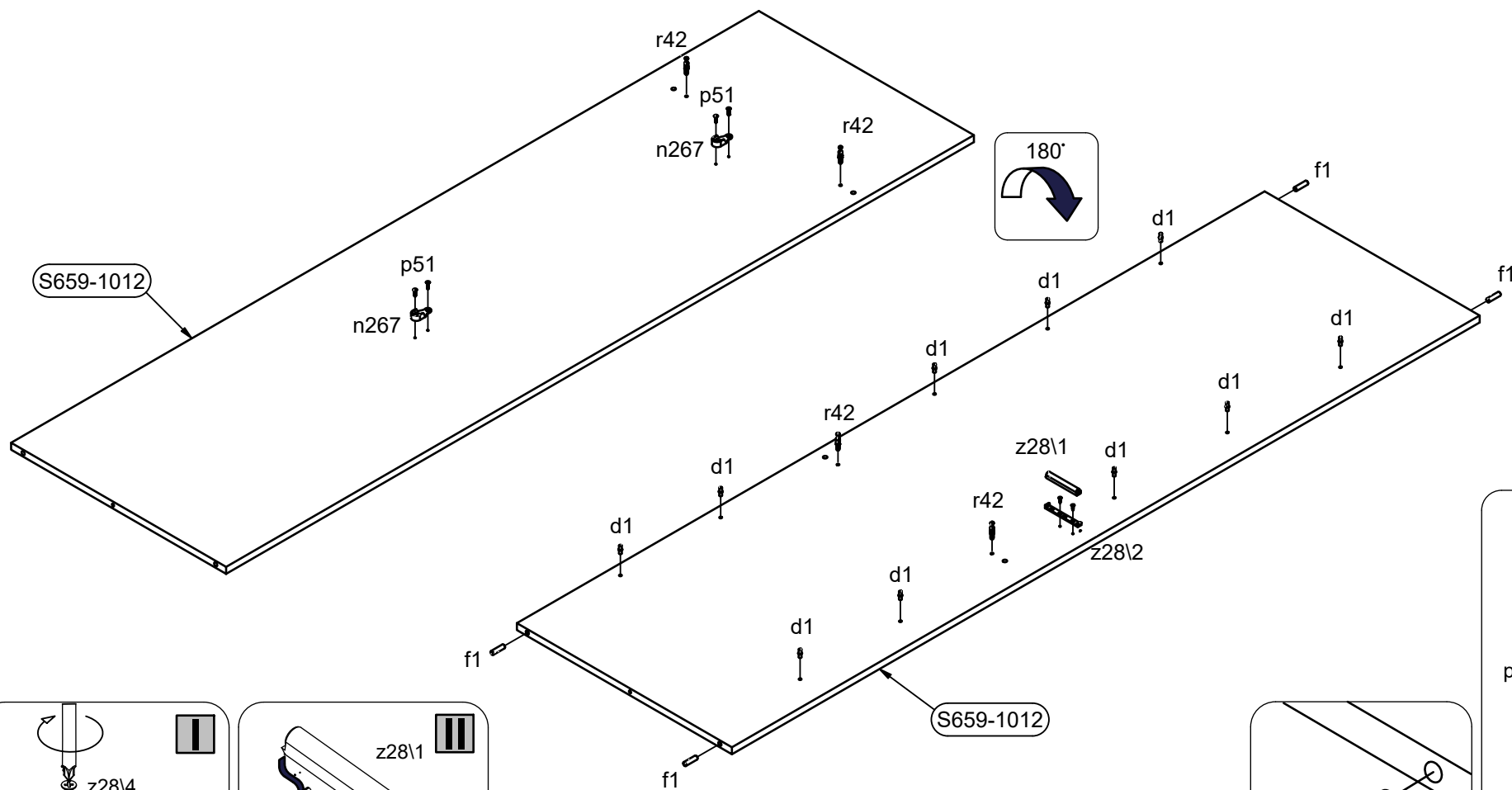

z28\4 2x 3x12mm

4

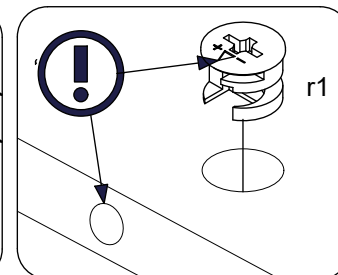
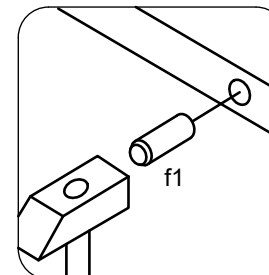
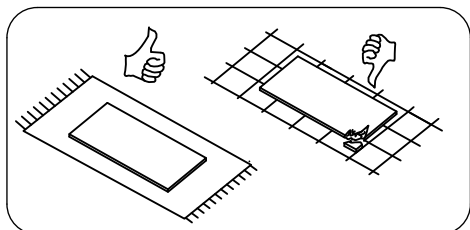
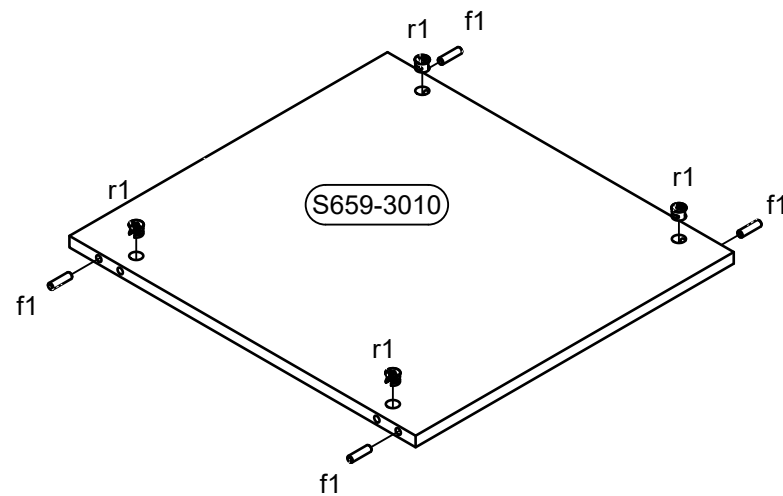
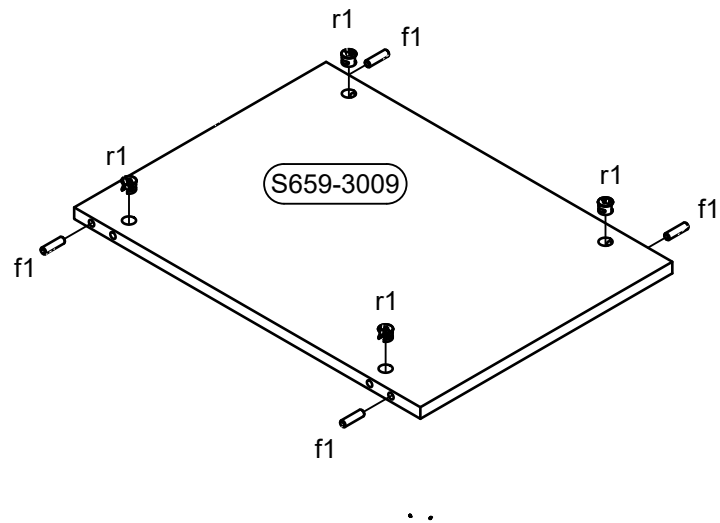
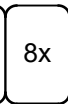
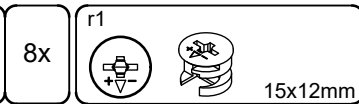
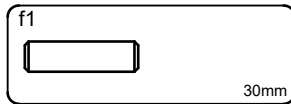

5

z28\4 3x12mm 1x



z28\3 1x



p51 3.5x15mm 4x



a203 1x

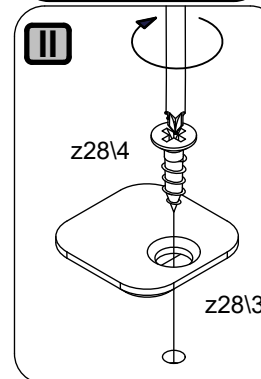
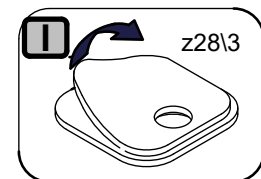
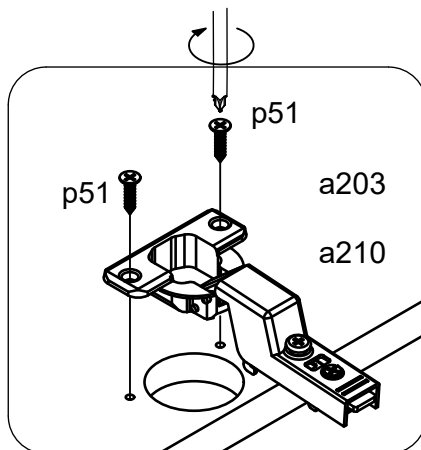
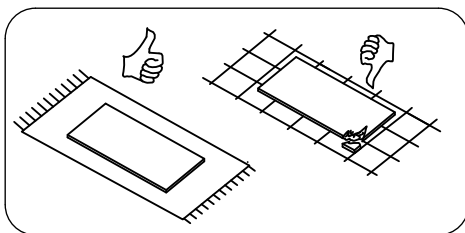
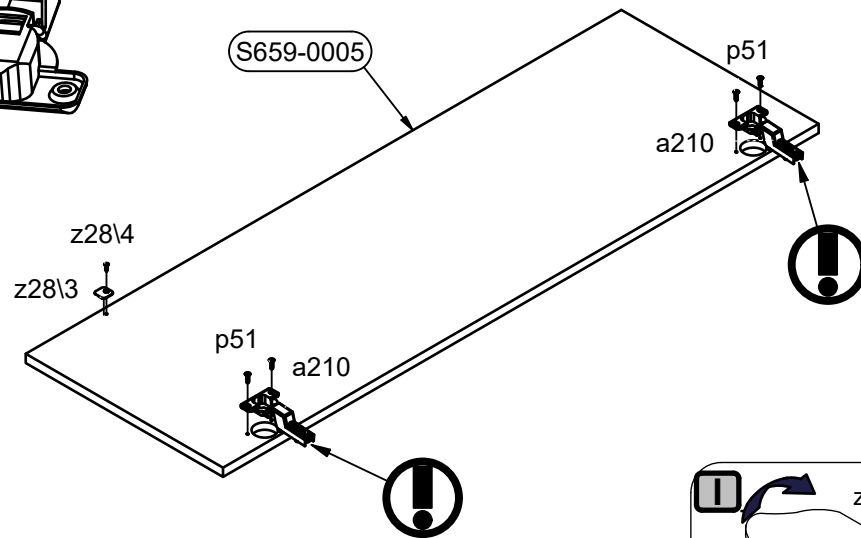
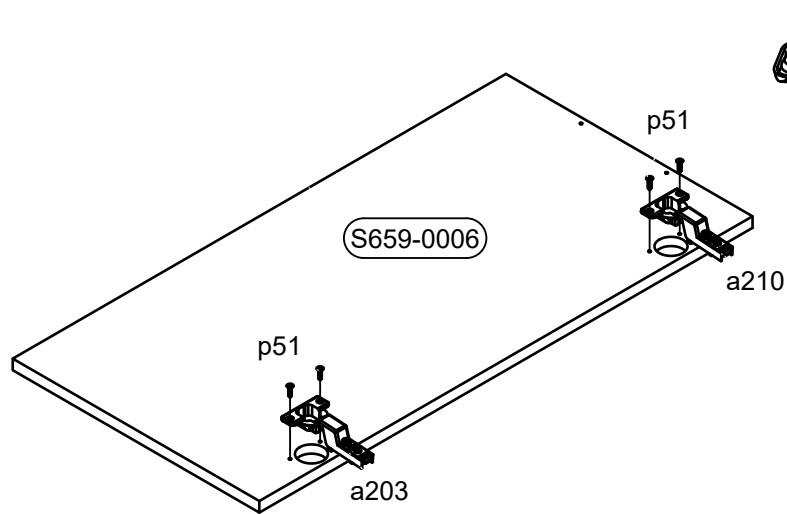
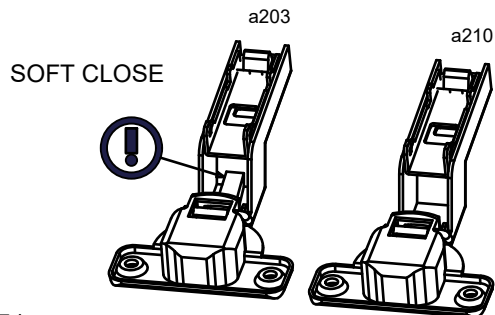

a210 3x

6

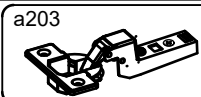

2x



1x



3.5x15mm

8x

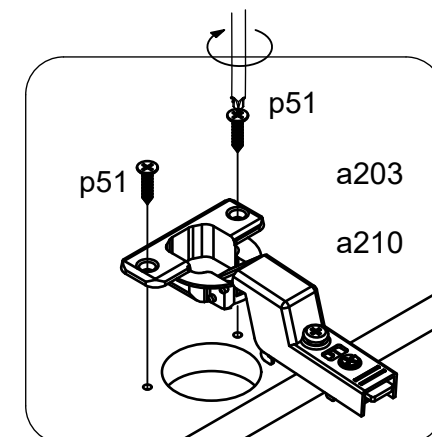
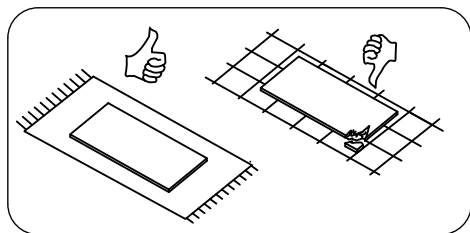
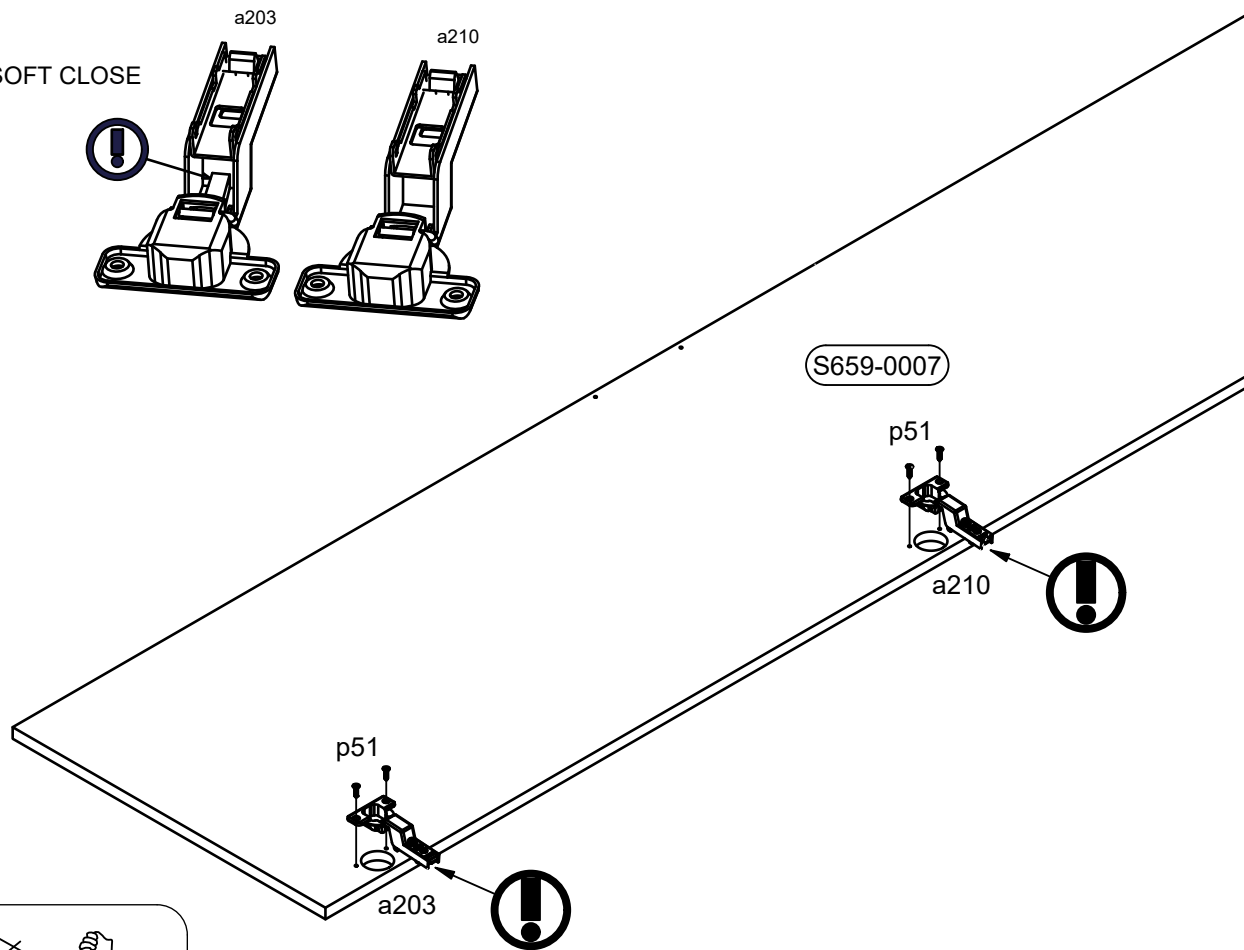
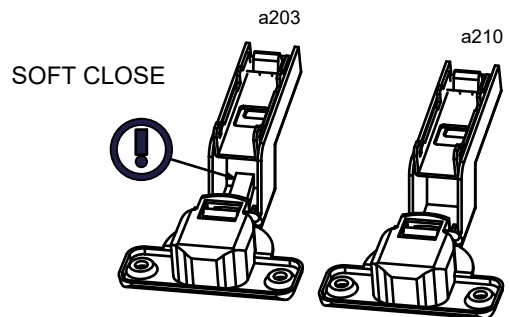

7

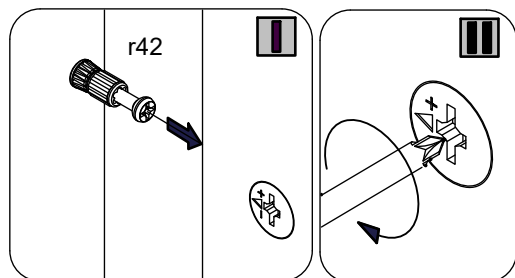
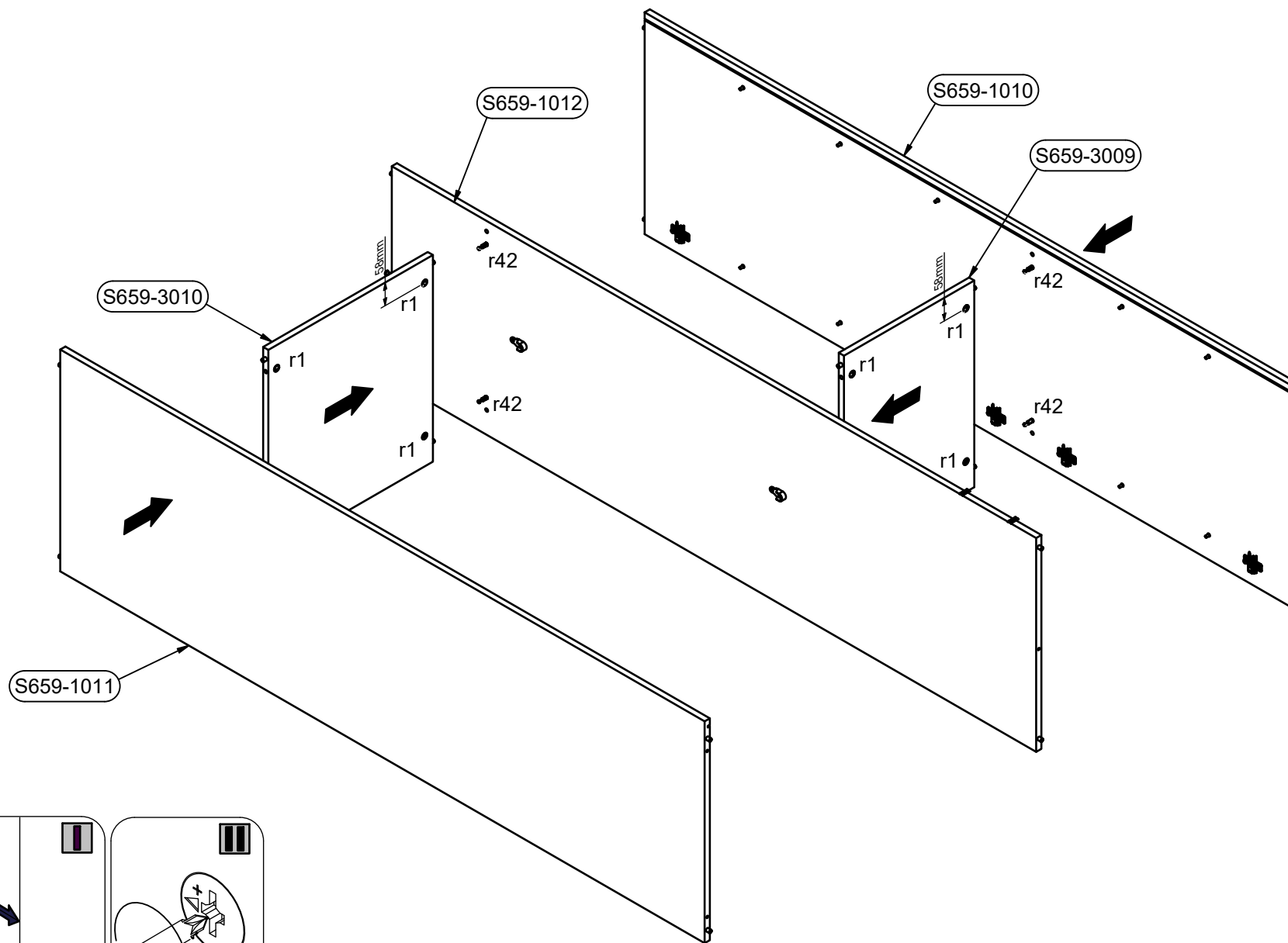

8

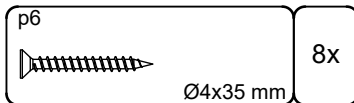
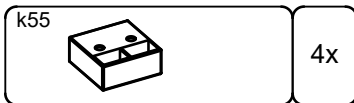
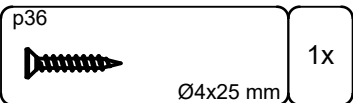
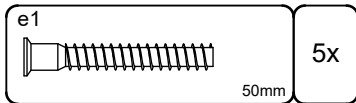

9

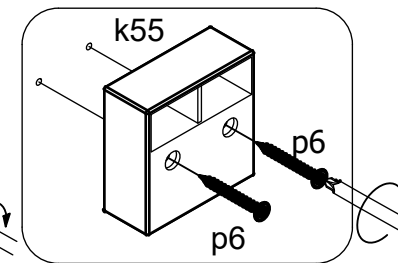
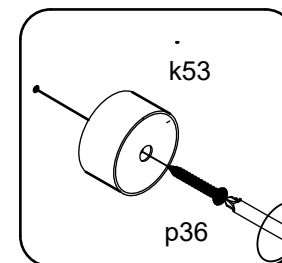
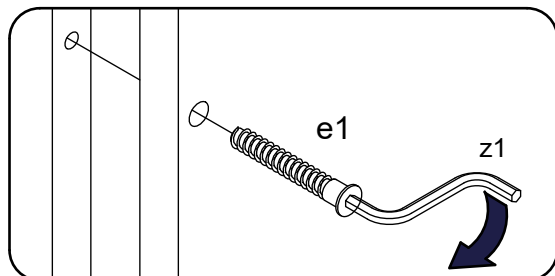
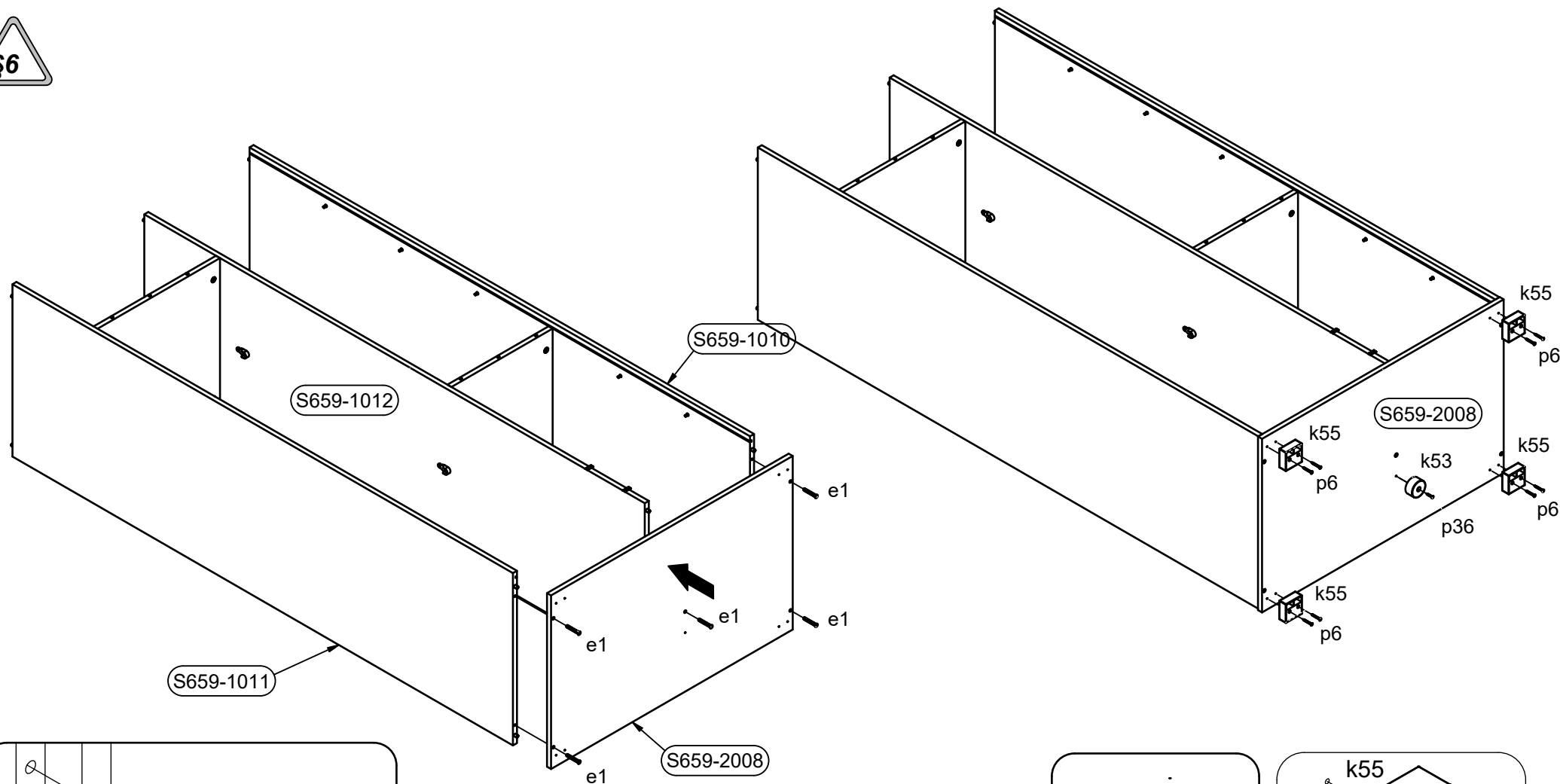

10

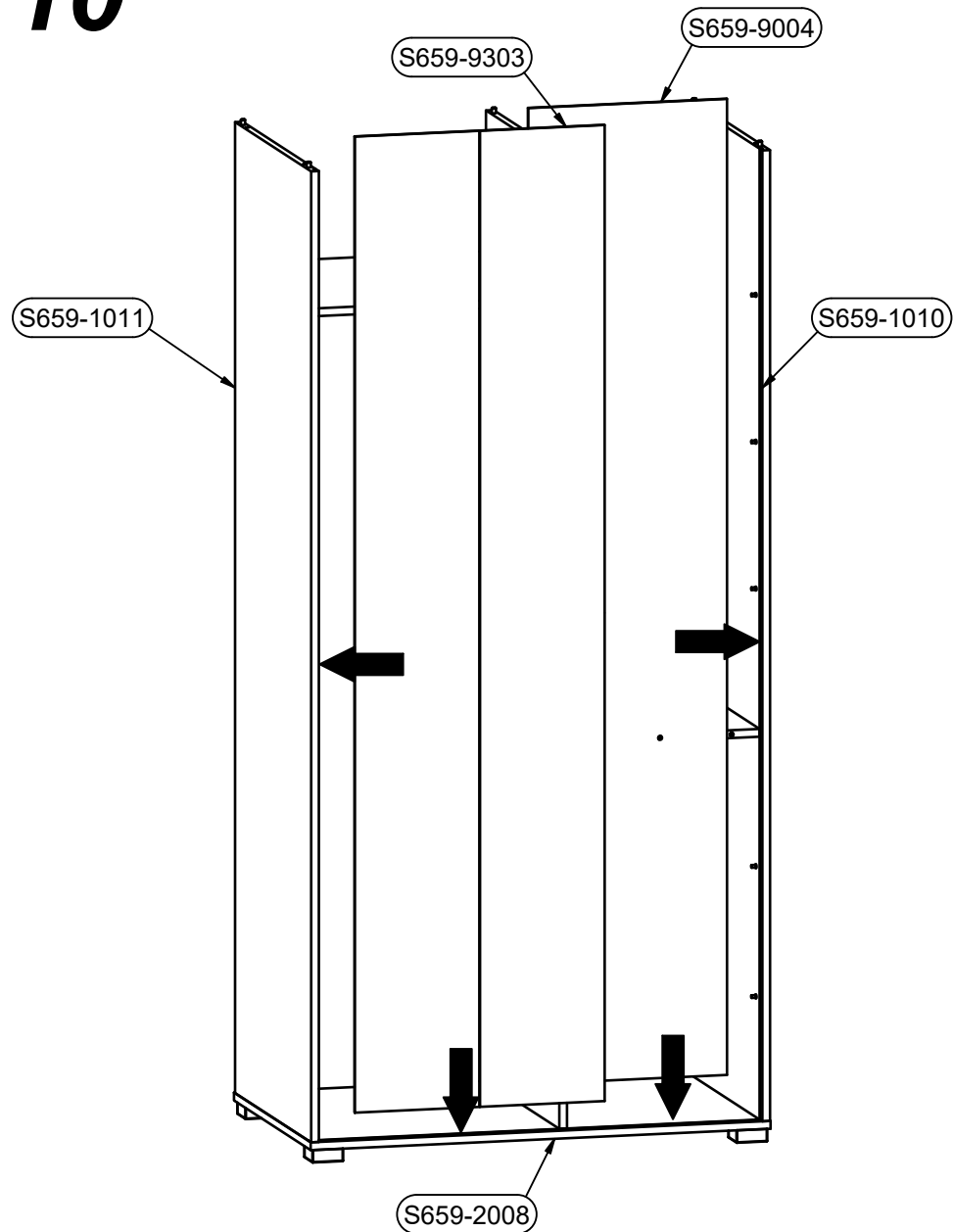

e1 50mm 5x **11**

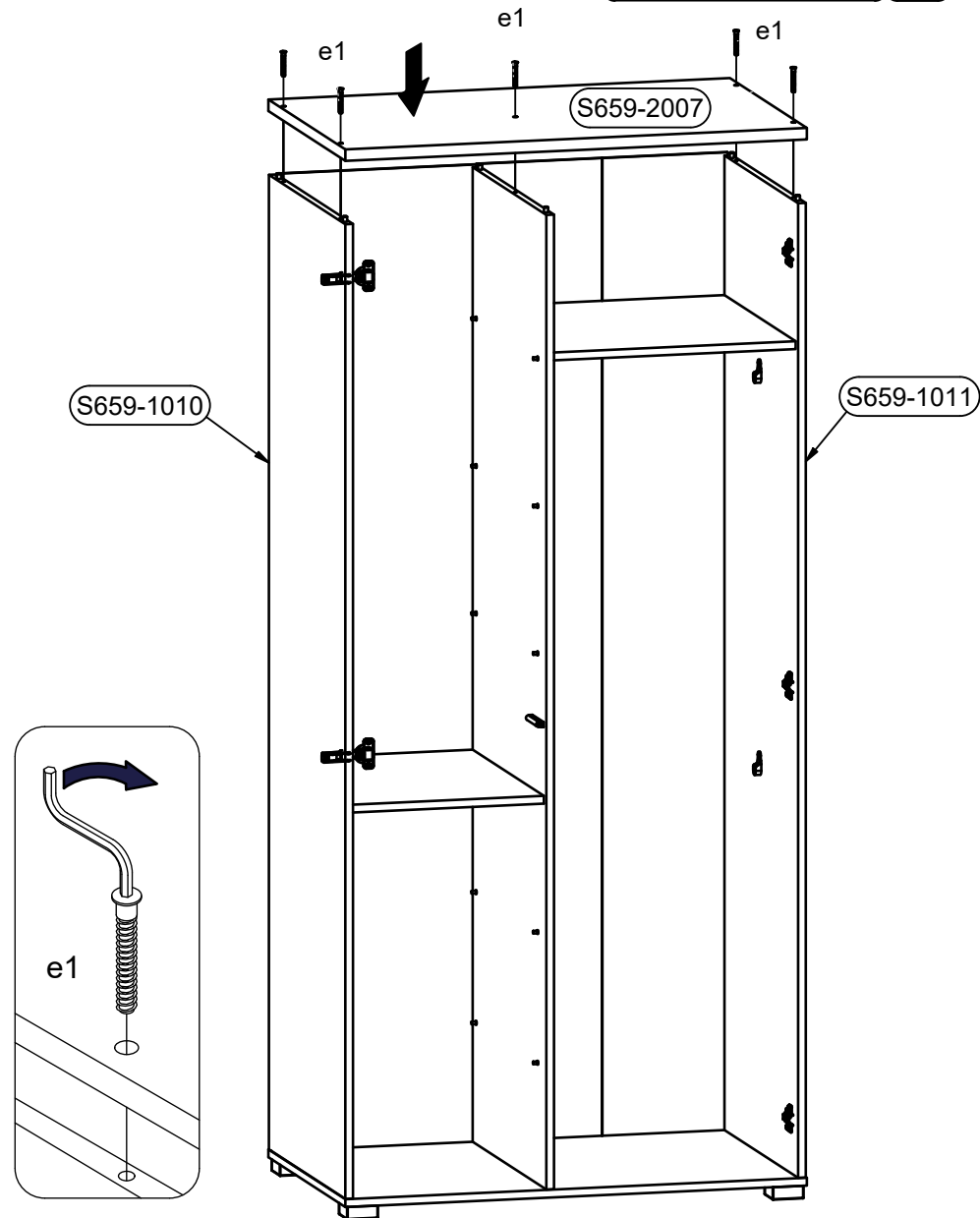

12

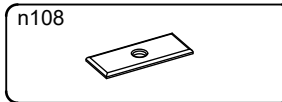

13x

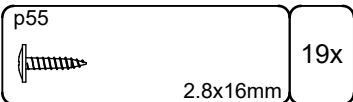

19x

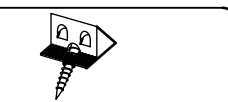

14x

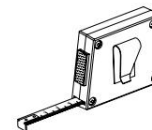

A=B
!

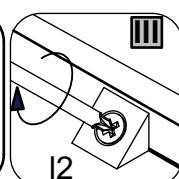
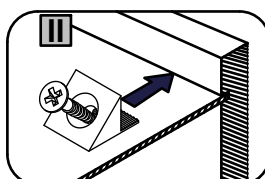
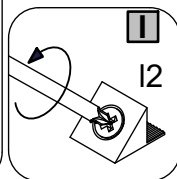
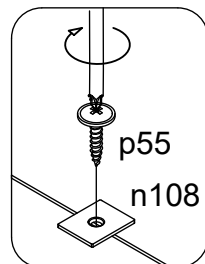
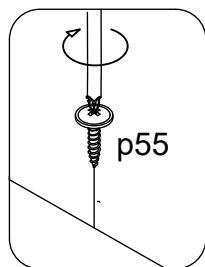
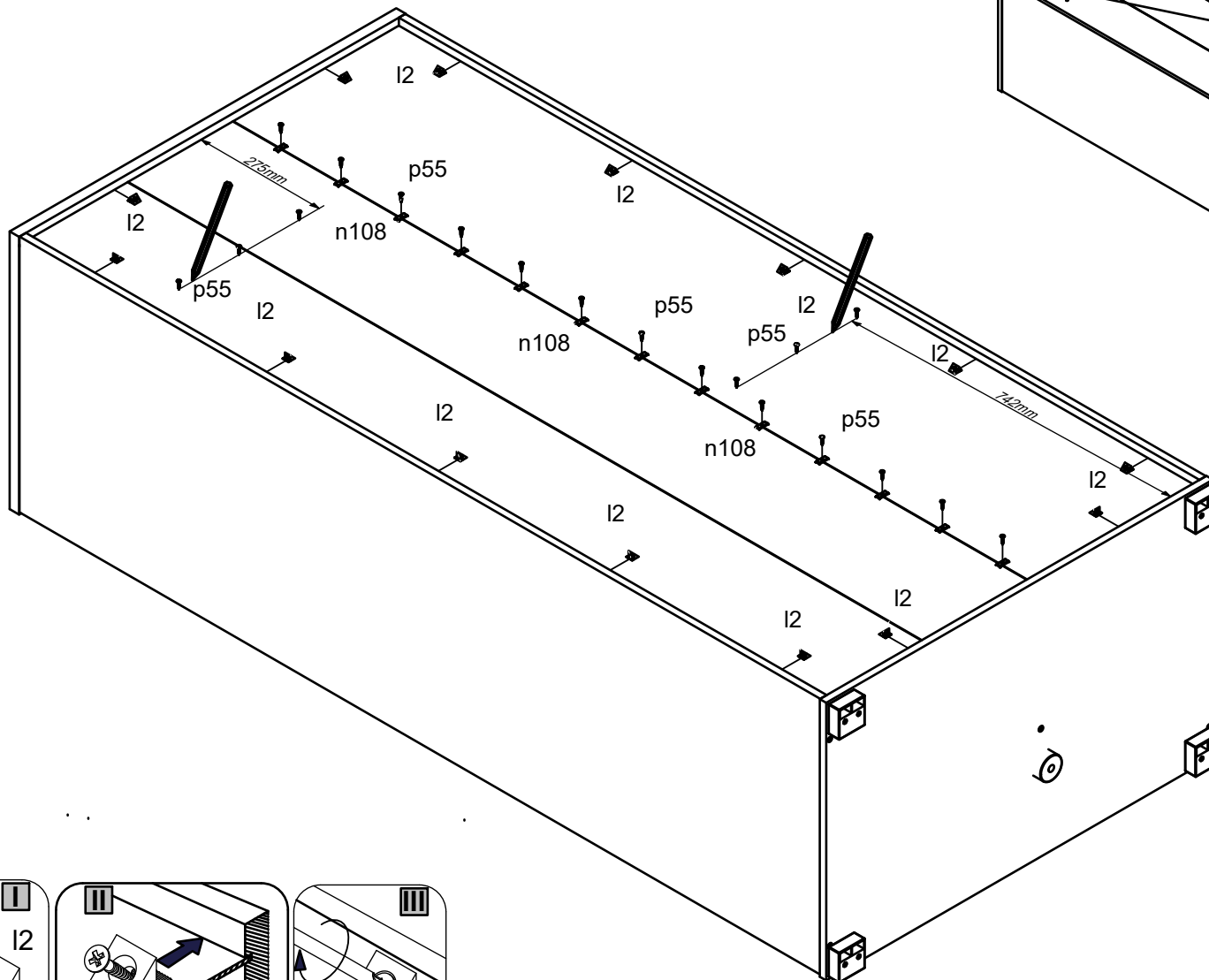
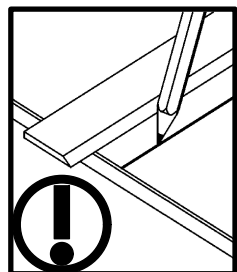
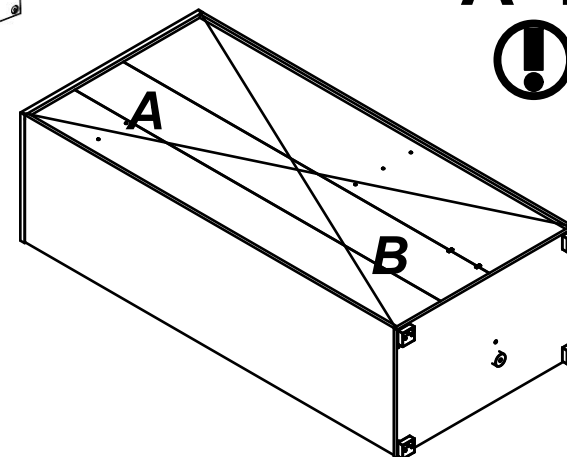

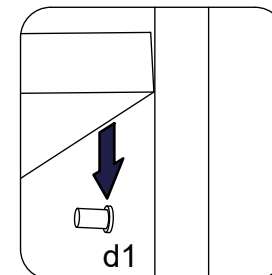
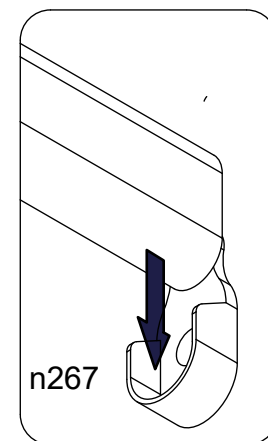
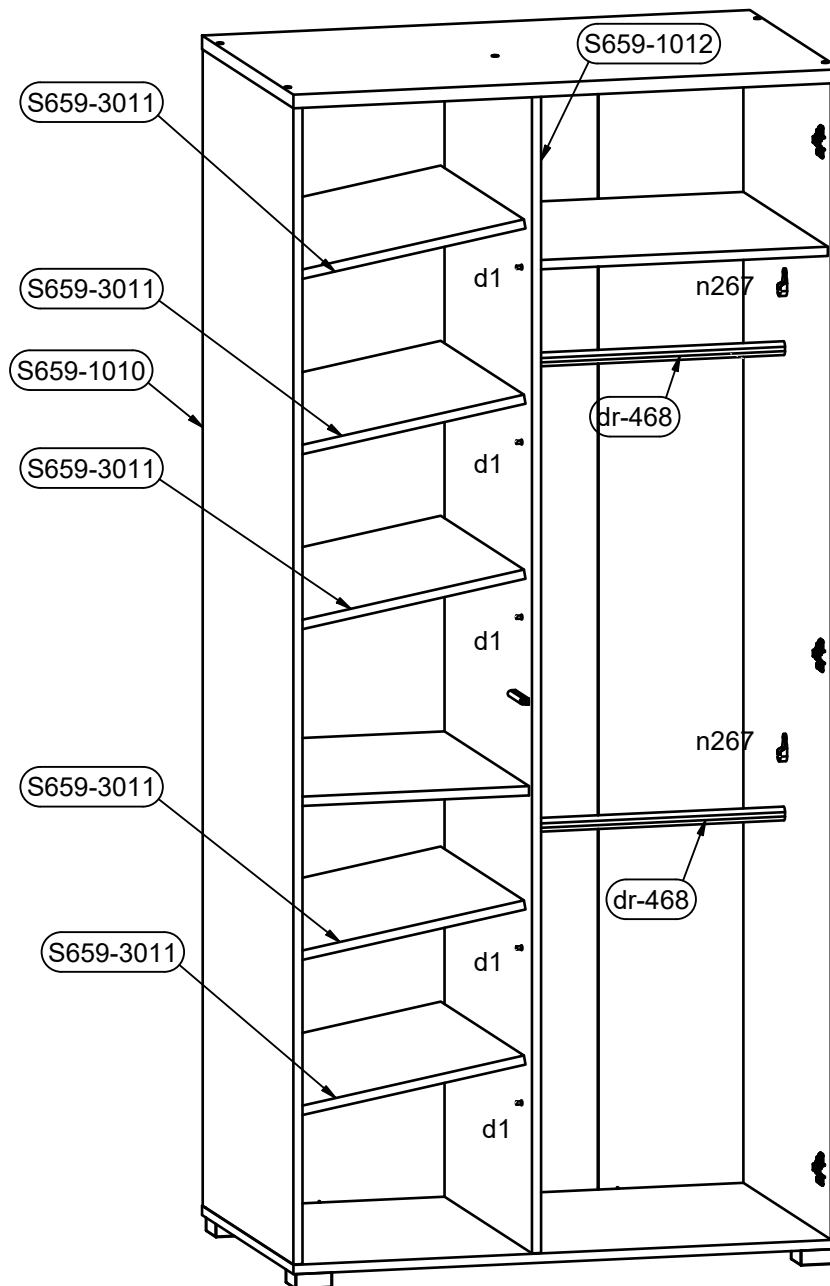

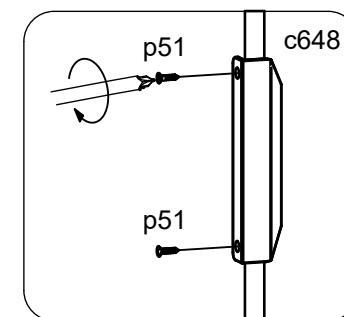
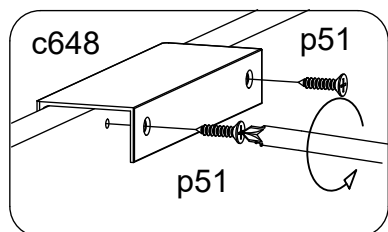
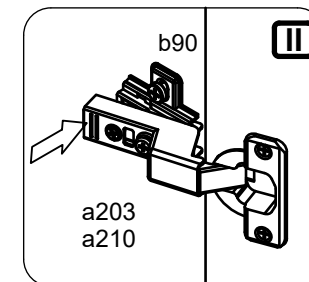
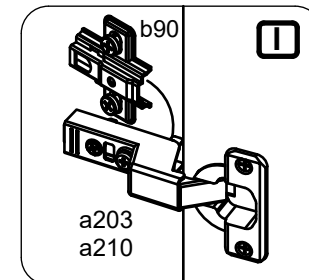
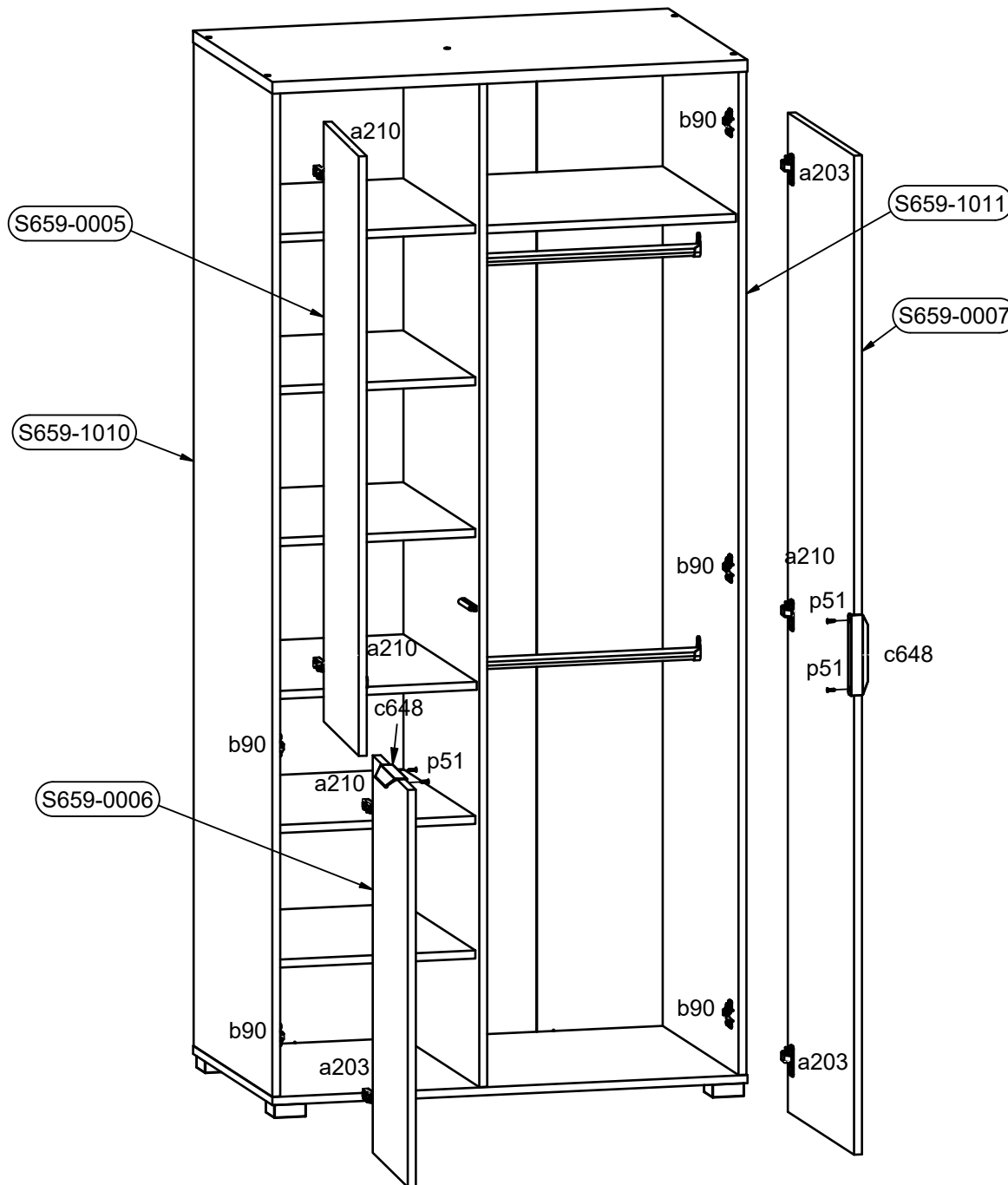
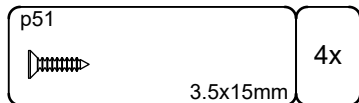
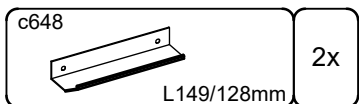

14

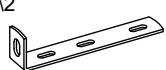

15

s68  Ø20mm	4x	n14\2 	1x	p51  3.5x15mm	2x
---	----	--	----	---	----

