

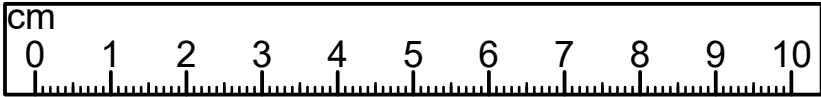

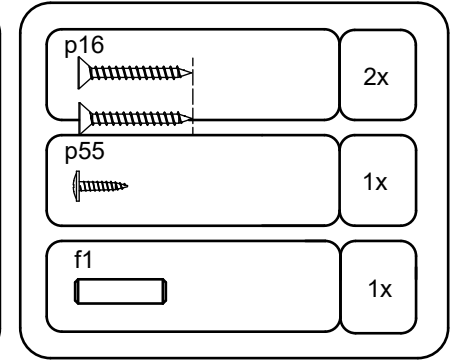

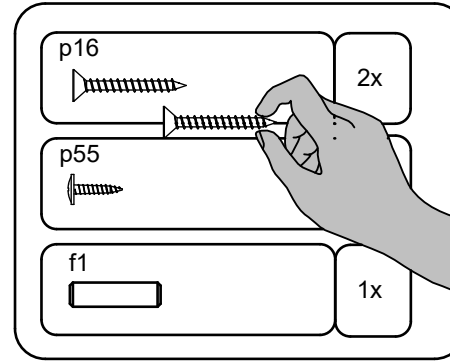

	B1	B2	C1	C2	C3	C4	D
S620-0012	-9	1308	196	16	1	1	2/2
S620-0014	-7	600	496	16	1	1	1/2
S620-1012	-8	1316	382	16	1	1	2/2
S620-1044	-	1316	382	16	1	1	2/2
S620-1045	-	1316	362	16	1	1	2/2
S620-2025	-	901	400	18	1	1	1/2
S620-2026	-	901	400	18	1	1	1/2
S620-3006	-7	466	358	16	1	1	1/2
S620-3007	-8	384	346	16	3	1	1/2
S620-3032	-	465	340	16	3	1	1/2
S620-5062	-.15	1308	22	16	5	1	2/2
S620-7004	-.13	1308	250	16	1	1	2/2
S620-9006	-8	1326	398	2,5	1	1	2/2
S620-9304	-9	1326	479	2,5	1	1	2/2

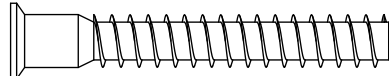
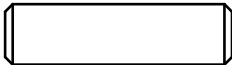

1:1

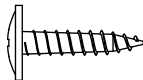

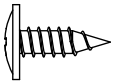
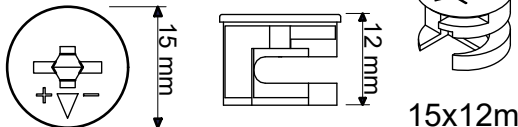
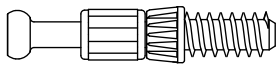
<p>d4</p>  <p>Ø6.3x15 mm</p>	<p>2x</p>	<p>e1</p>  <p>50mm</p>	<p>6x</p>	<p>f1</p>  <p>30mm</p>	<p>16x</p>
<p>p51</p>  <p>3.5x15mm</p>	<p>12x</p>	<p>p55</p>  <p>2.8x16mm</p>	<p>12x</p>	<p>p94</p>  <p>Ø4x28 mm</p>	<p>6x</p>
<p>p140</p>  <p>Ø3.5x12 mm</p>	<p>2x</p>	<p>r1</p>  <p>15 mm 12 mm 15x12mm</p>	<p>10x</p>	<p>r42</p> 	<p>10x</p>

~~1:1~~

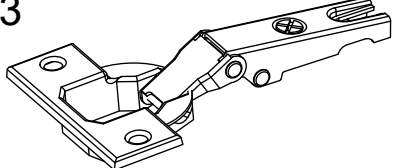
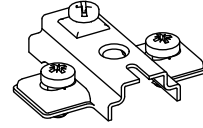
<p>a83</p> 	<p>5x</p>	<p>b42</p> 	<p>5x</p>
---	-----------	--	-----------

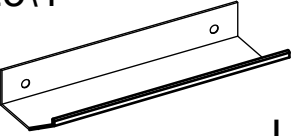
<p>c623\1</p>  <p>L84/64mm</p>	<p>1x</p>
---	-----------

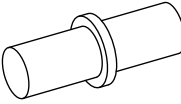
<p>d1</p>  <p>fi5mm</p>	<p>24x</p>
---	------------

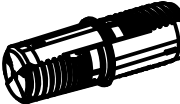
<p>f88</p> 	<p>20x</p>
--	------------

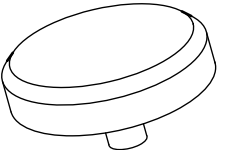
<p>k27</p>  <p>fi48x19mm</p>	<p>5x</p>
---	-----------

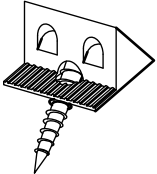
<p>l2</p> 	<p>14x</p>
--	------------

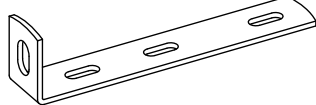
<p>n14\2</p> 	<p>1x</p>
--	-----------

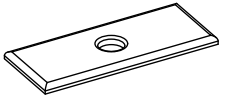
<p>n108</p> 	<p>8x</p>
---	-----------

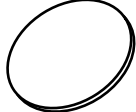
<p>o21</p>  <p>Ø8/1,8mm</p>	<p>2x</p>
---	-----------

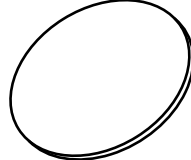
<p>s68</p>  <p>Ø20mm</p>	<p>6x</p>
--	-----------

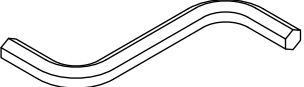
<p>z1</p>  <p>4mm</p>	<p>1x</p>
--	-----------

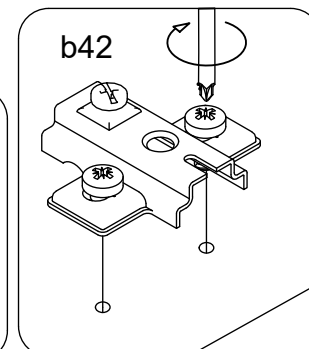
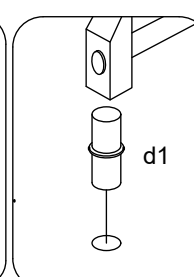
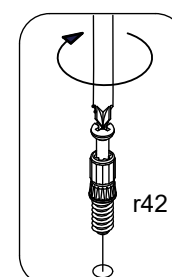
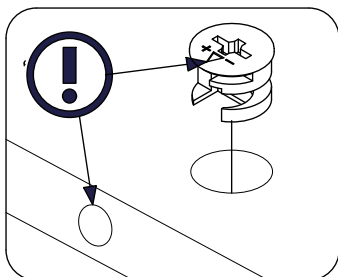
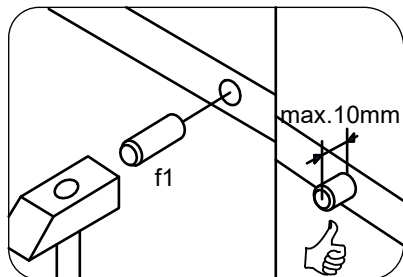
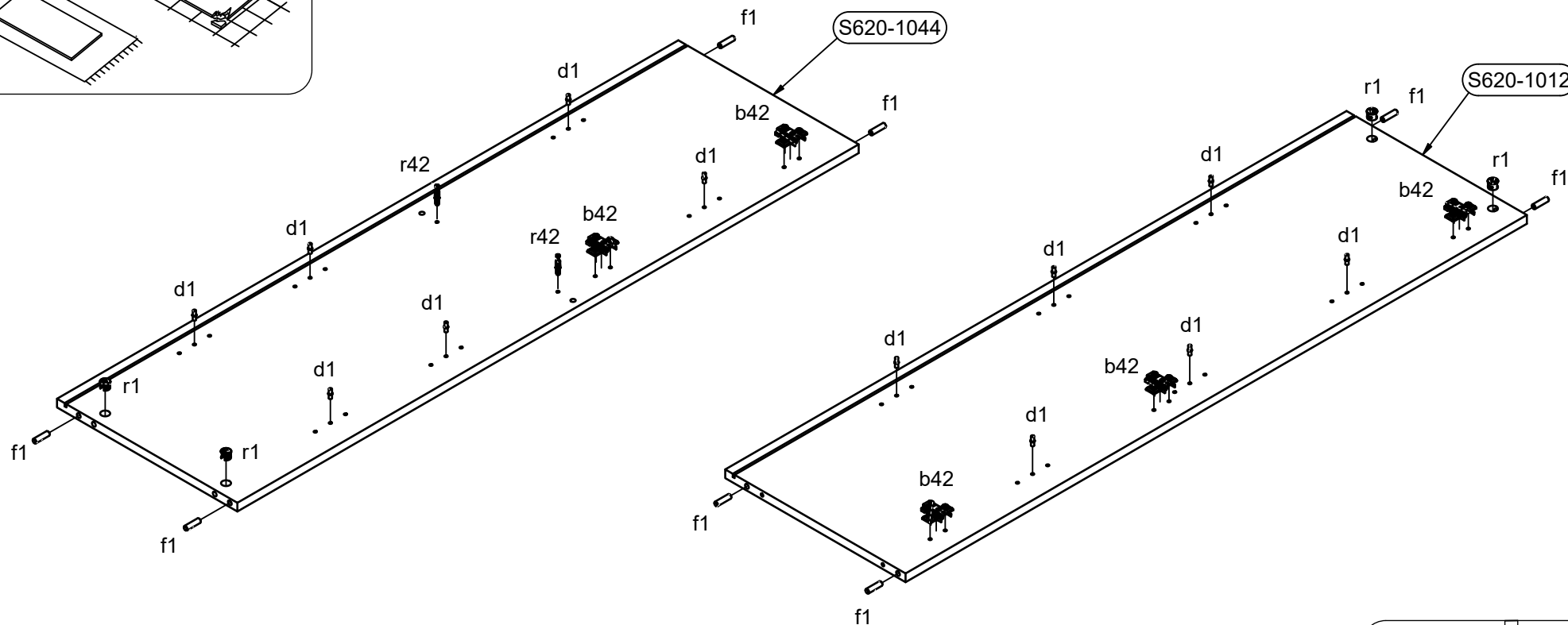
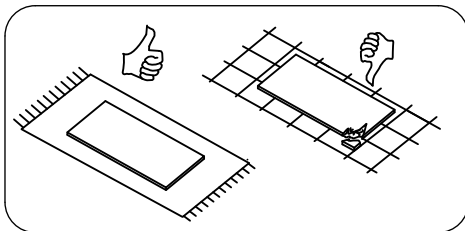
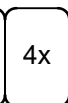
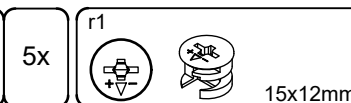
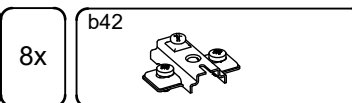
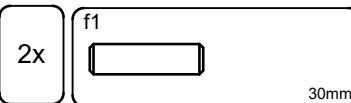
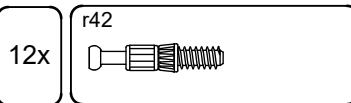
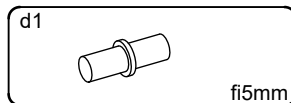

2

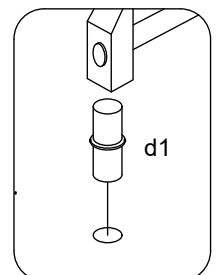
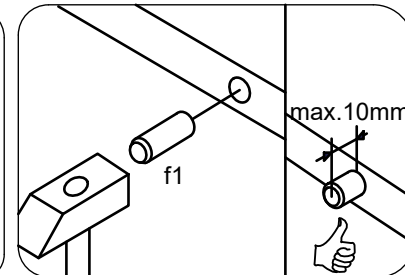
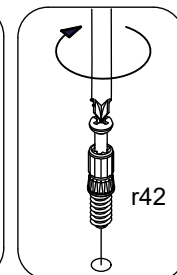
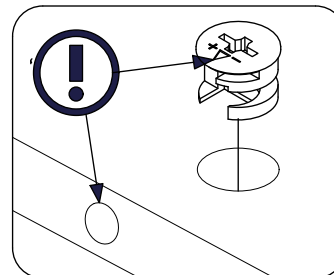
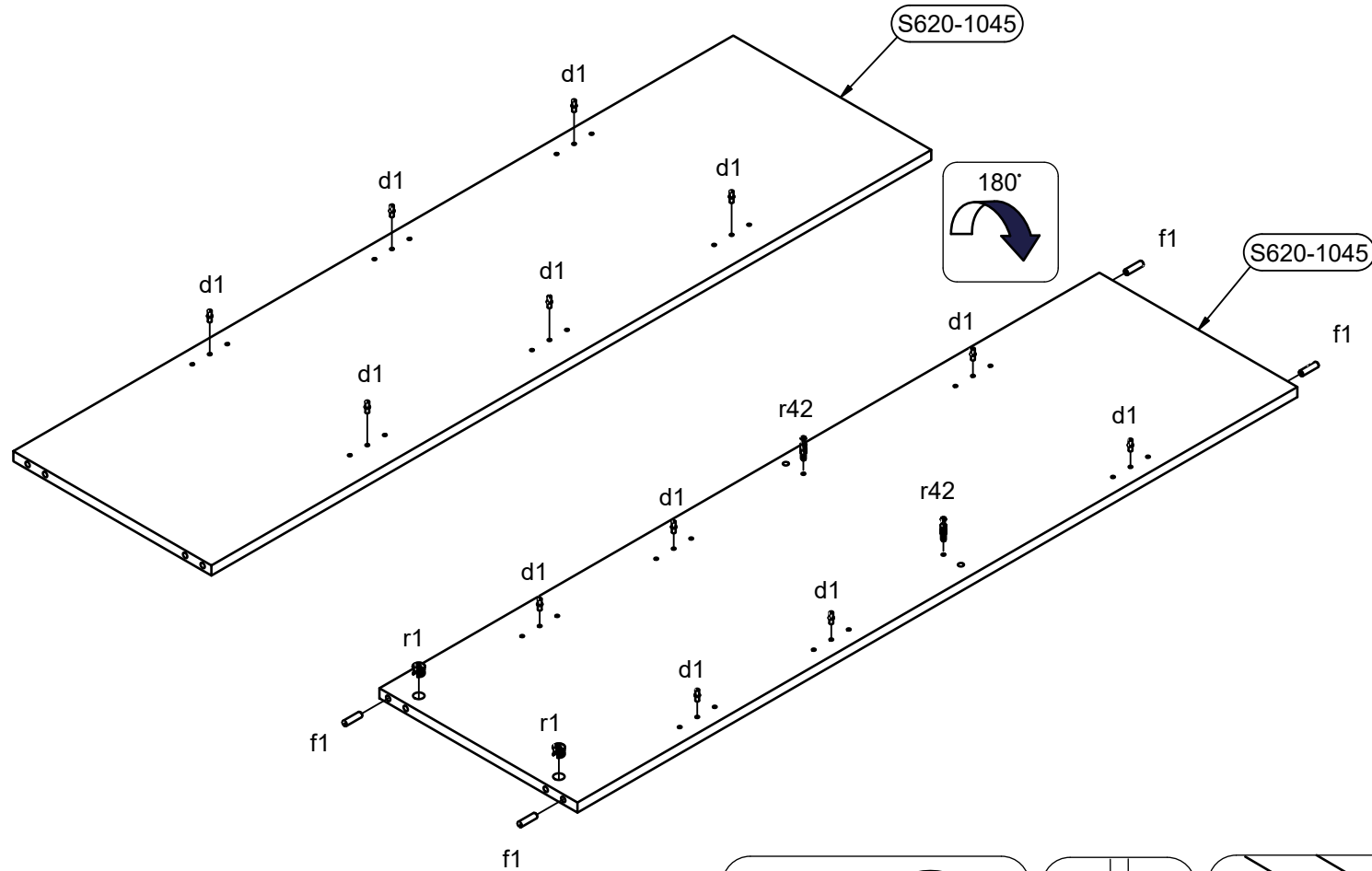
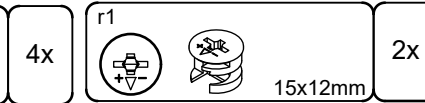
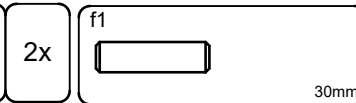
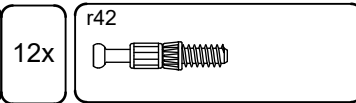
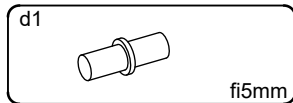

3

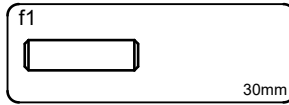

4x

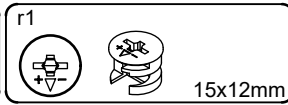

4x

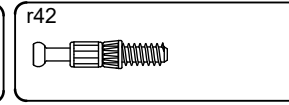

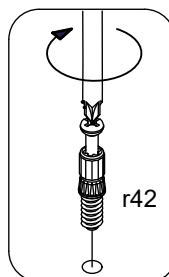
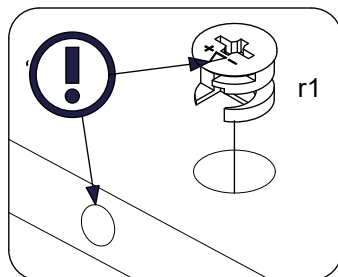
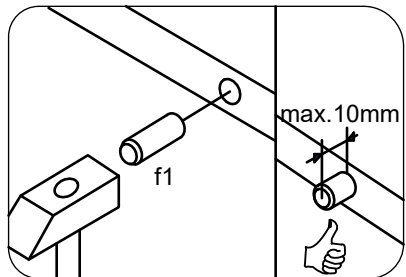
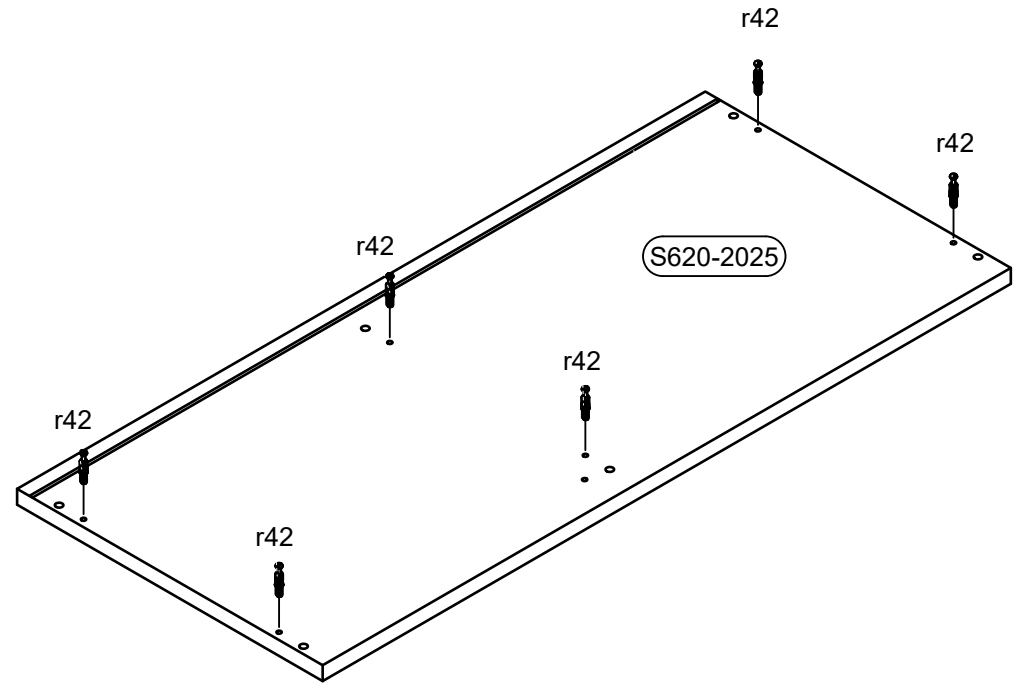
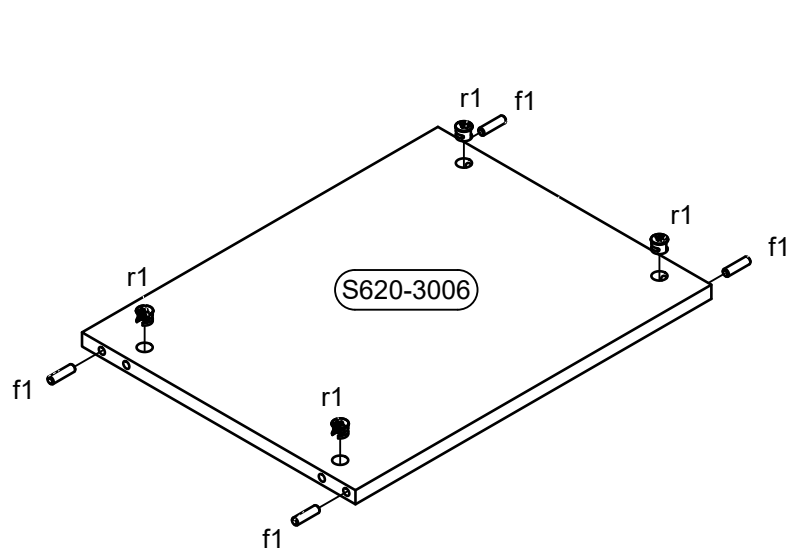
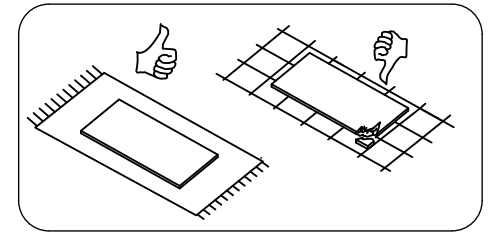

6x

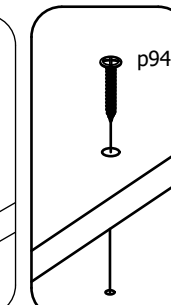
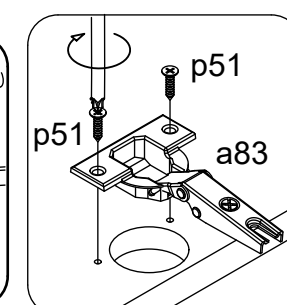
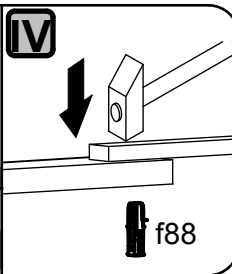
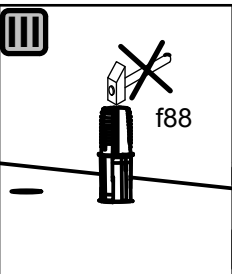
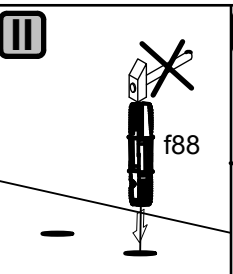
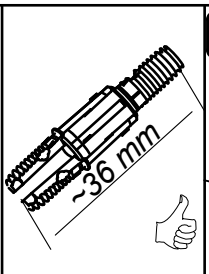
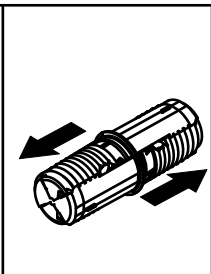
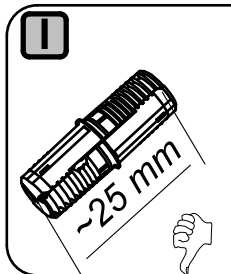
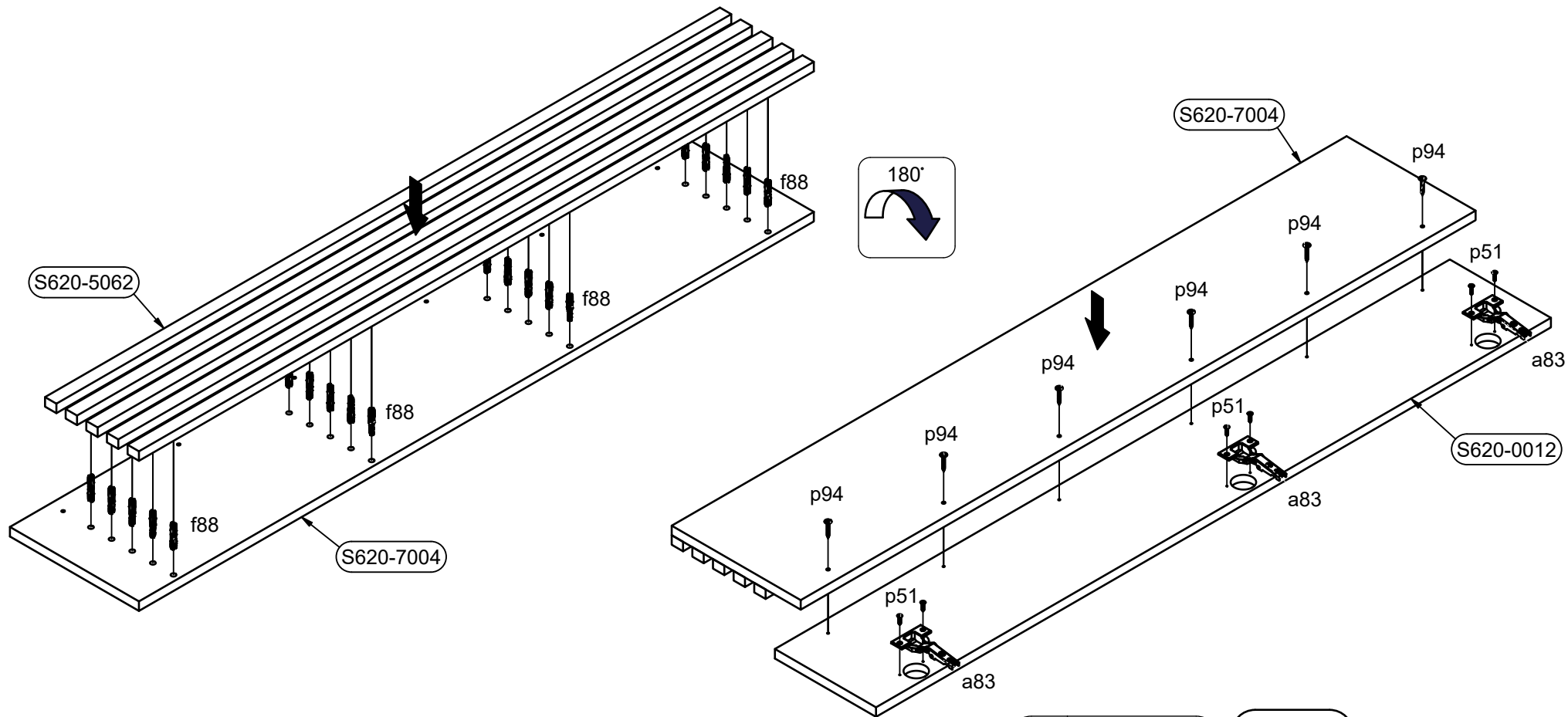
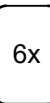
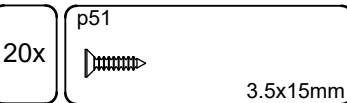
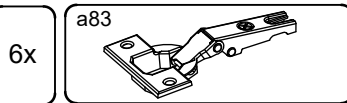
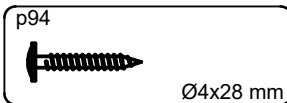

4

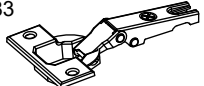

5

 <p>a83</p>	<p>2x</p>	 <p>p51</p>	<p>4x</p>
<p>3.5x15mm</p>			

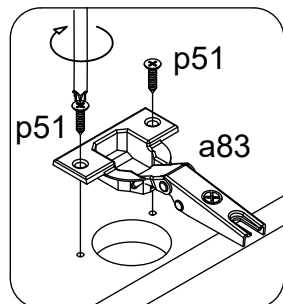
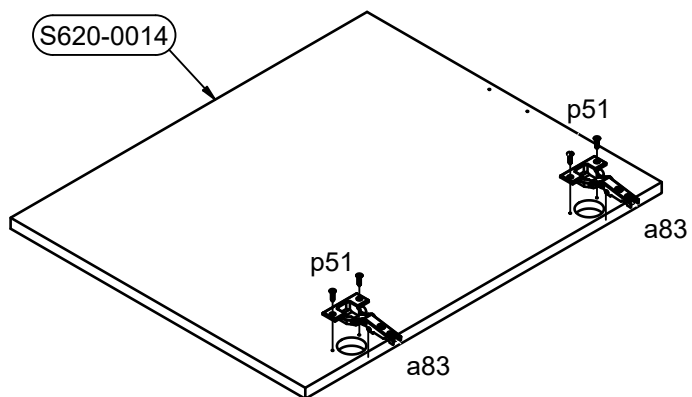
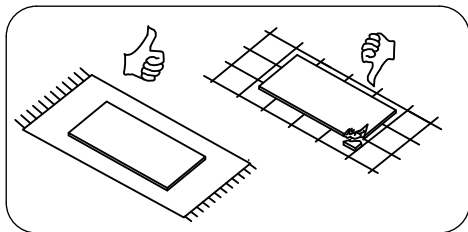

6

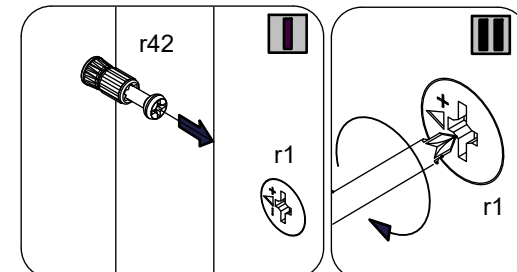
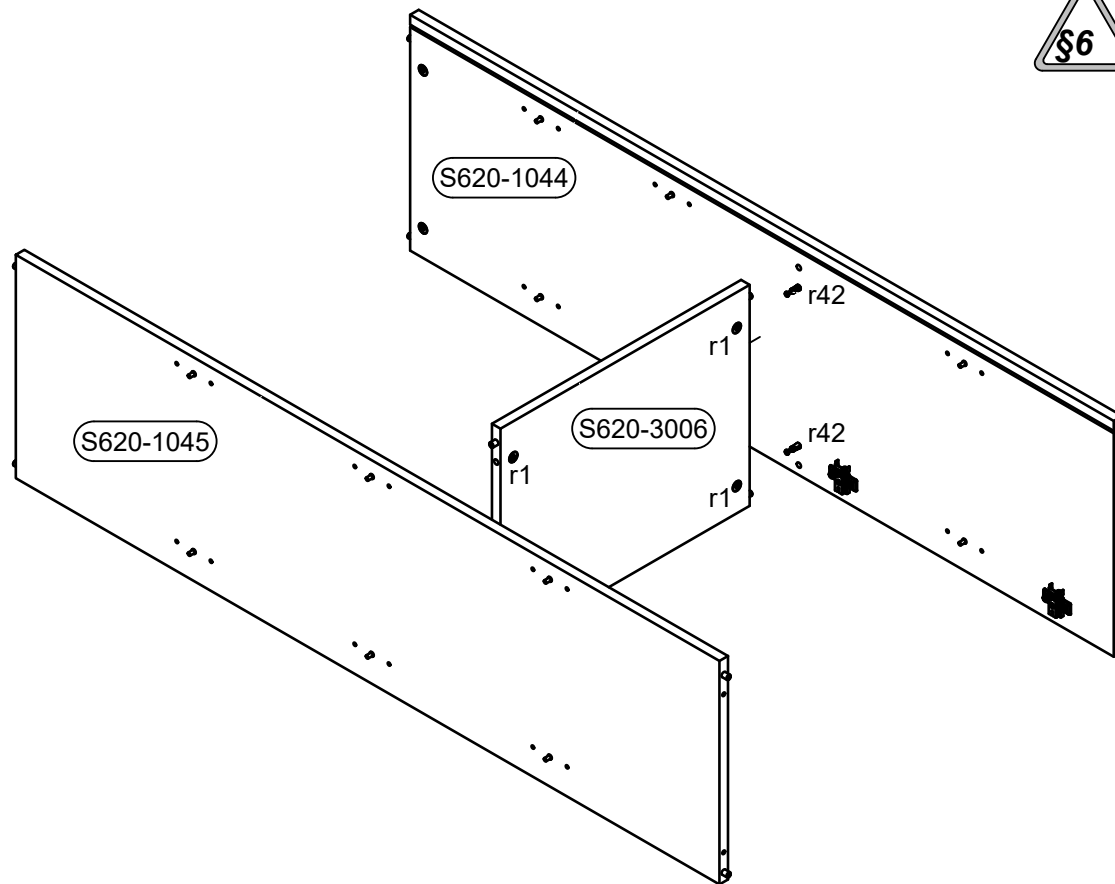

7

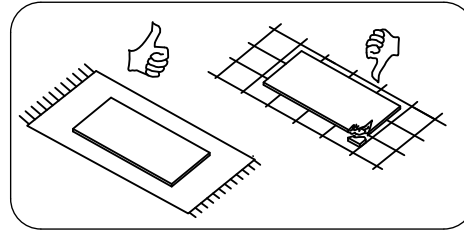

8

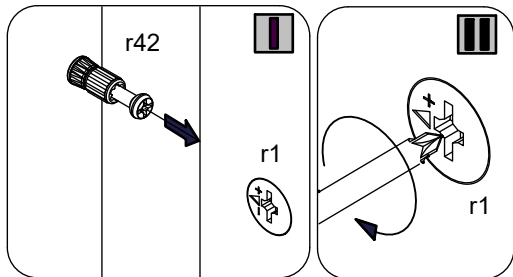
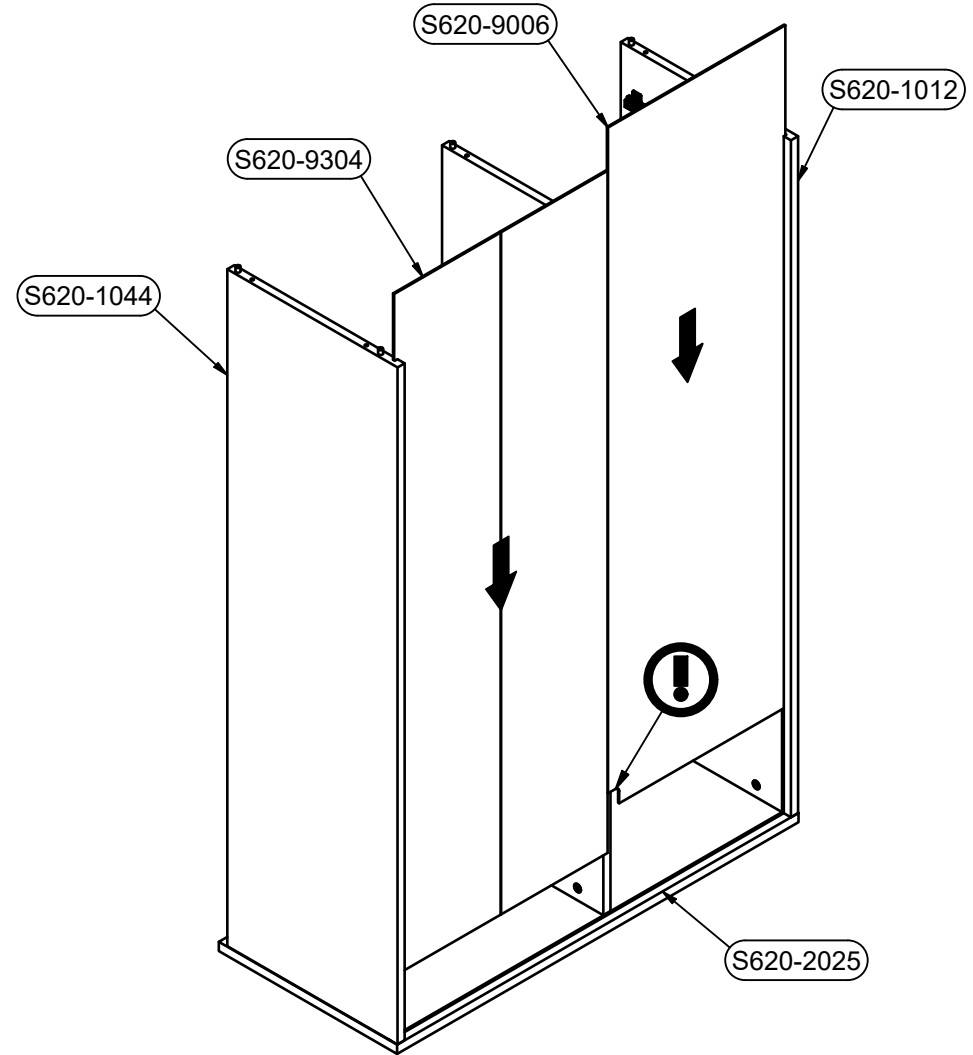
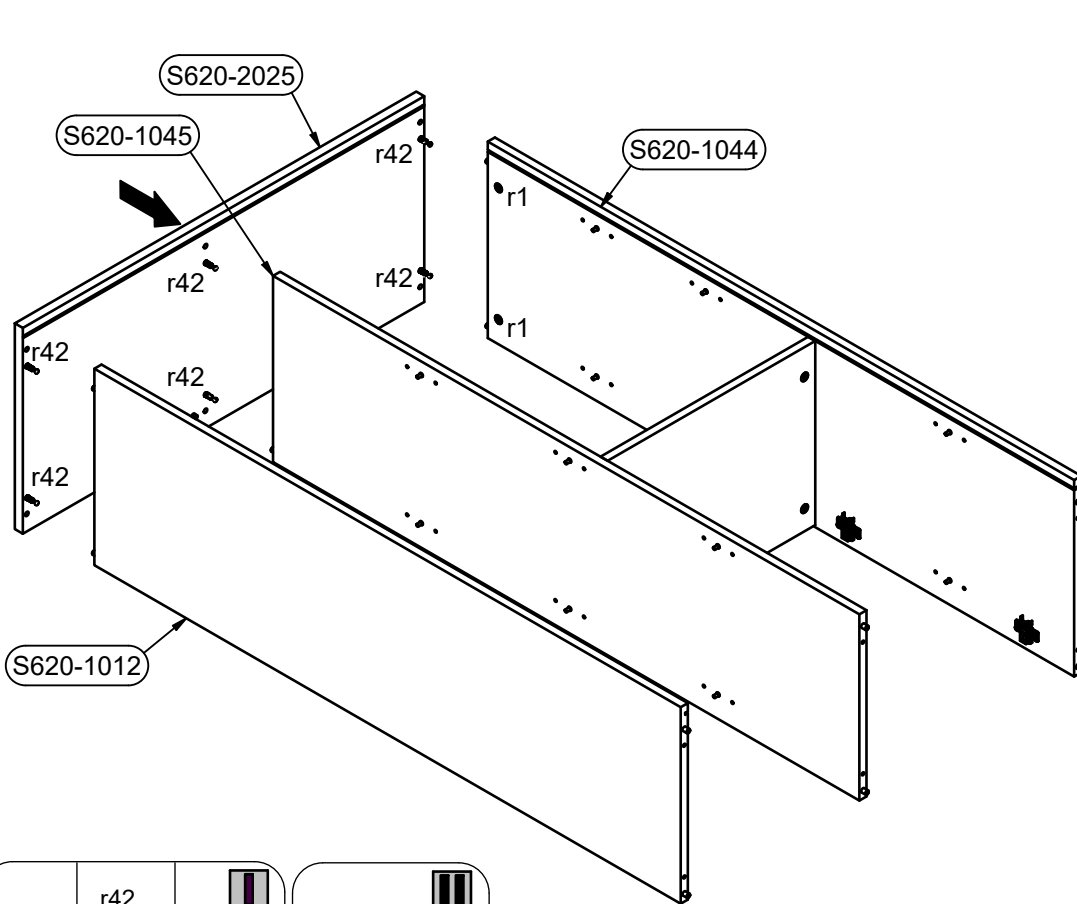

9

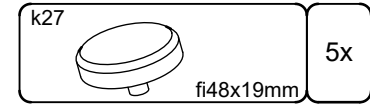
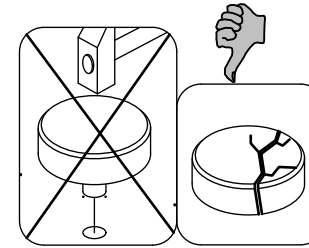
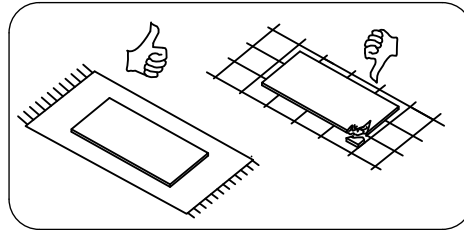
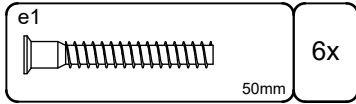

10

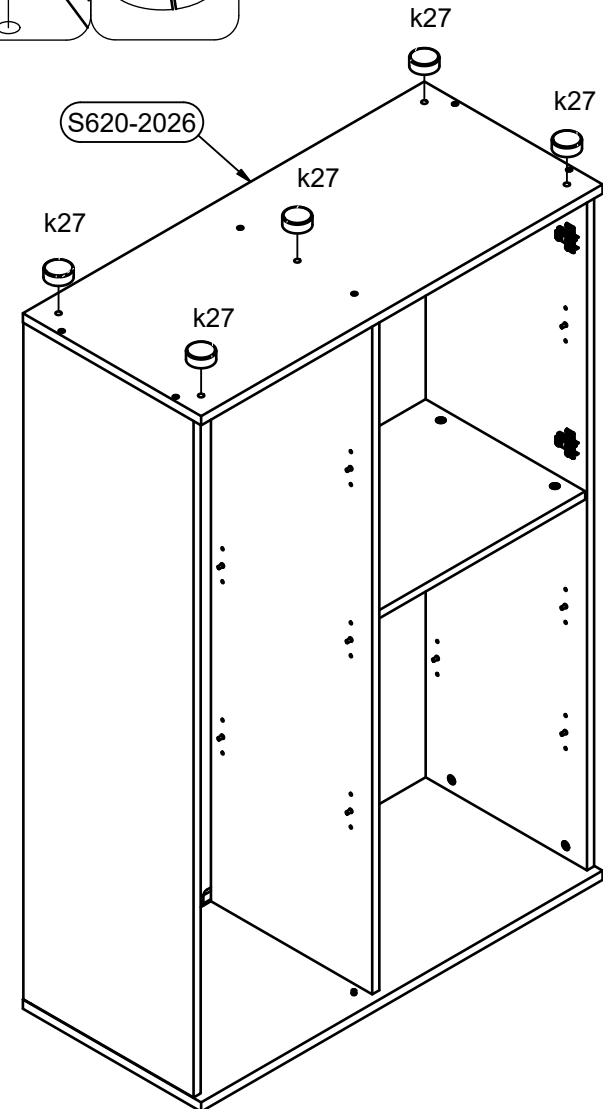
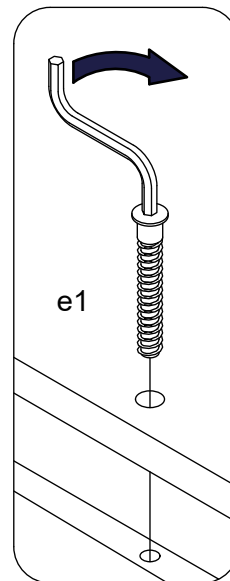
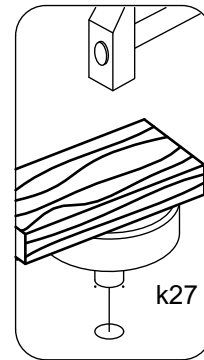
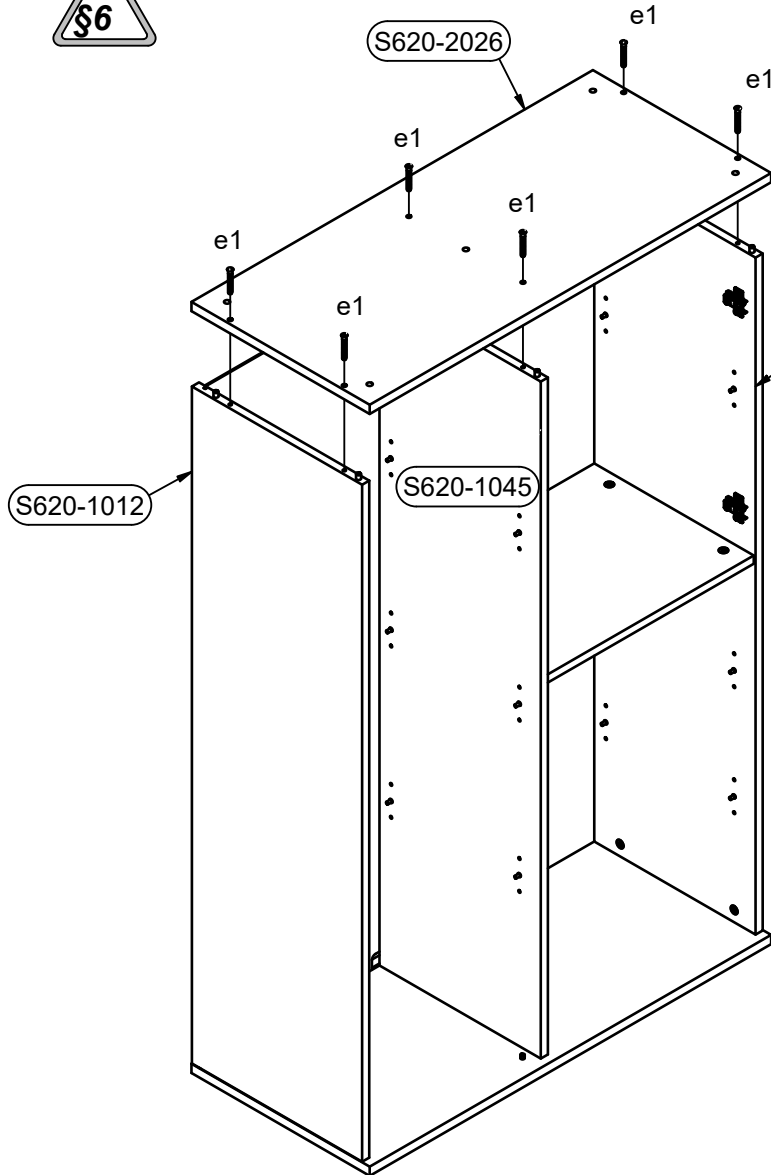

11



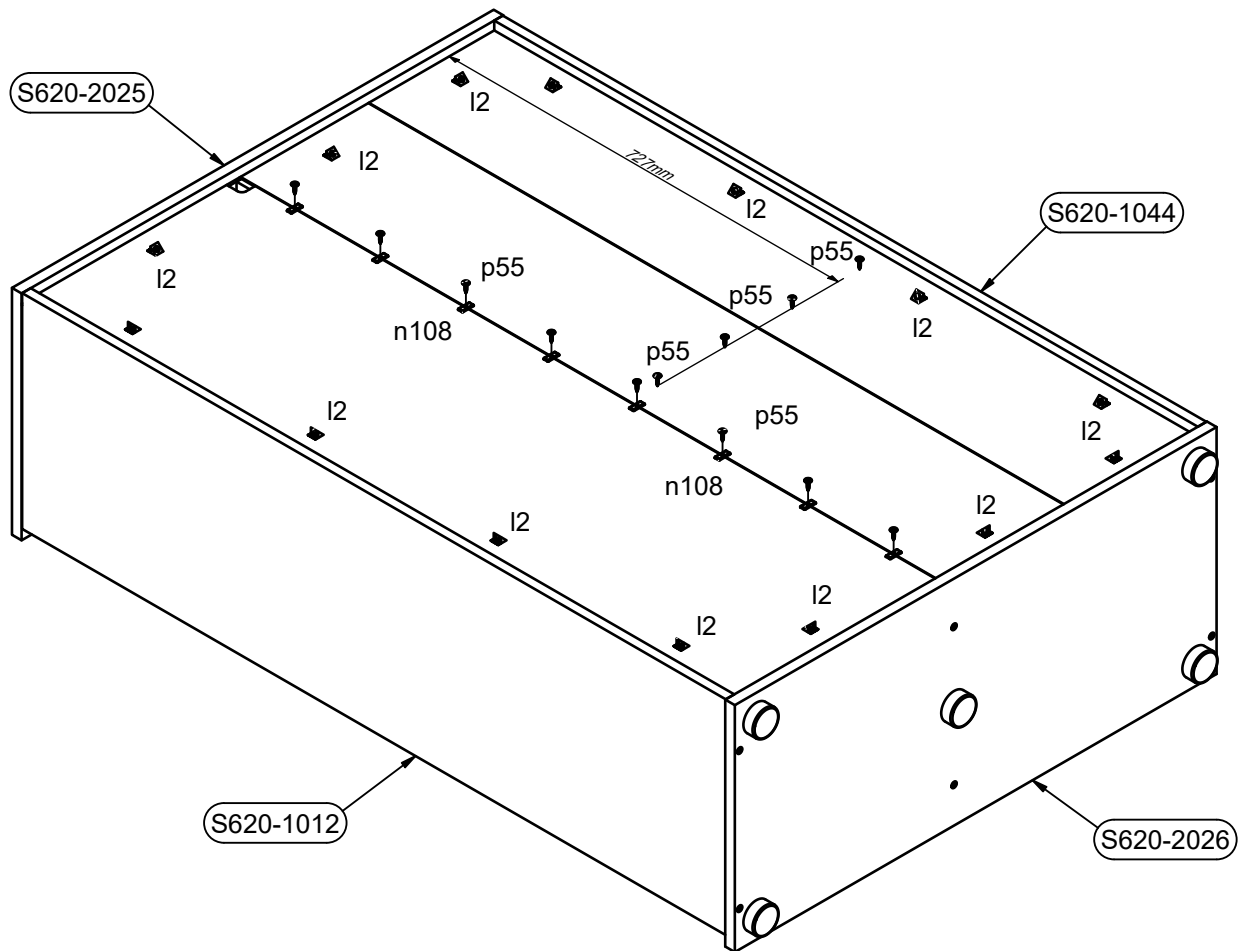
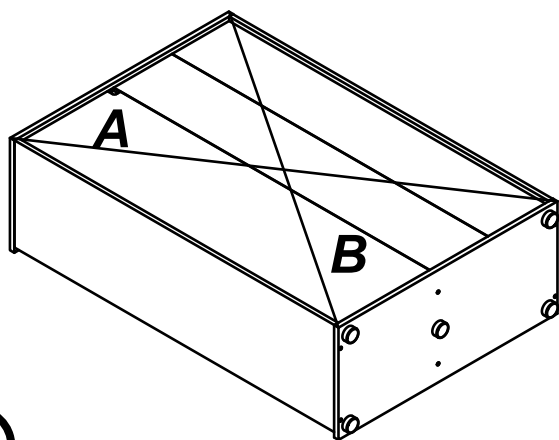
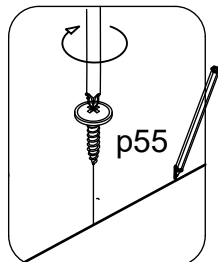
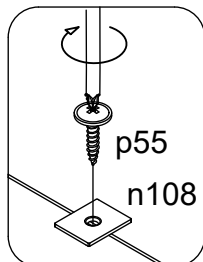

l2		14x	n108		8x	p55		2.8x16mm	8x
----	--	-----	------	--	----	-----	--	----------	----

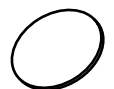
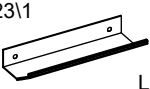

A=B

12

 <p>s68 Ø20mm</p>	<p>6x</p>	 <p>c623\1 L84/64mm</p>	<p>1x</p>	 <p>p140 Ø3.5x12 mm</p>	<p>2x</p>	 <p>d4 Ø6.3x15 mm</p>	<p>2x</p>
--	-----------	--	-----------	--	-----------	--	-----------

13

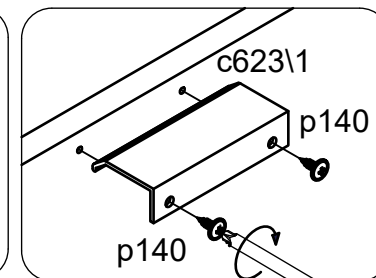
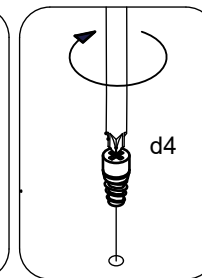
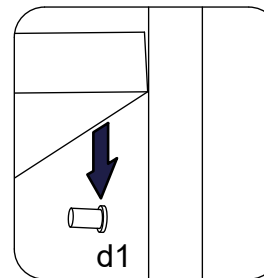
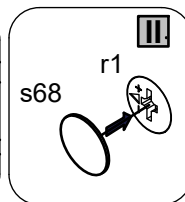
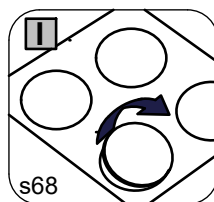
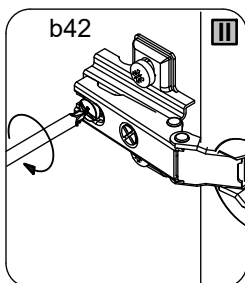
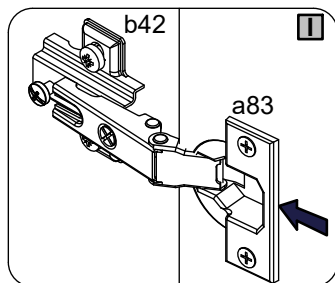
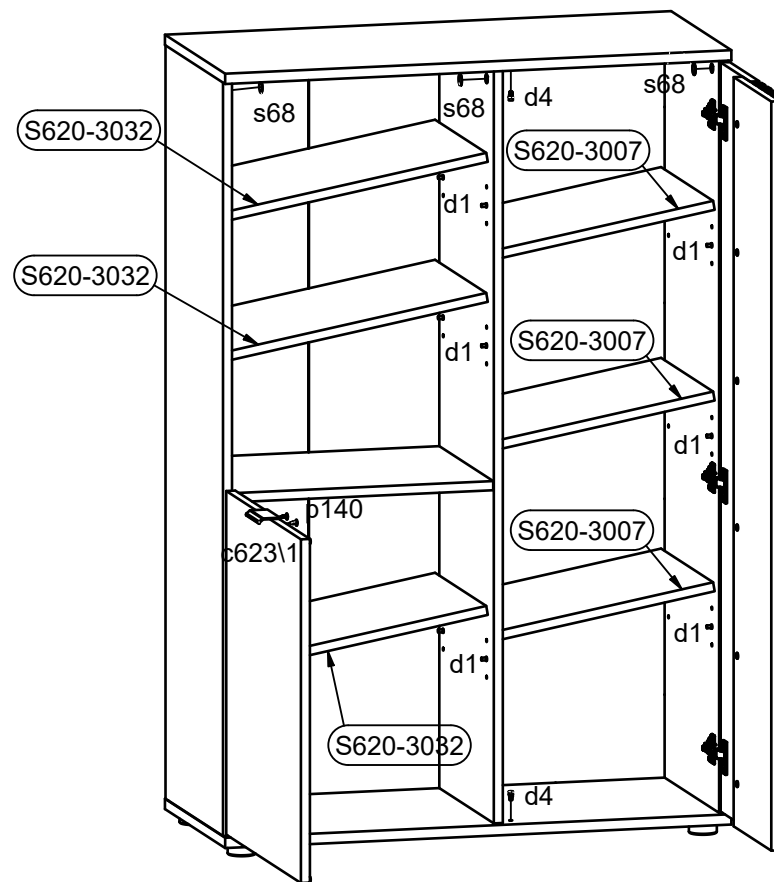
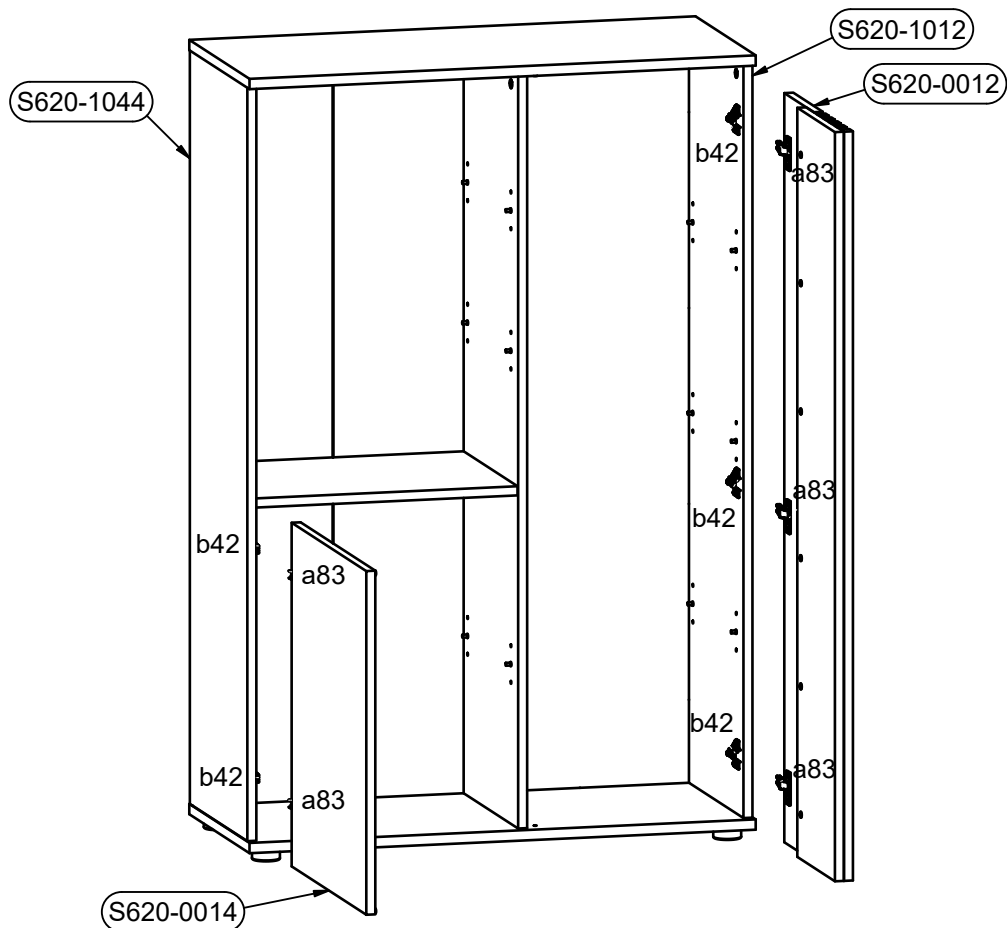

14

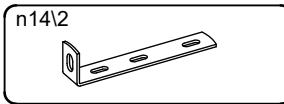

1x

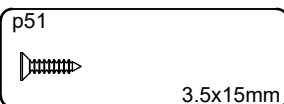

2x

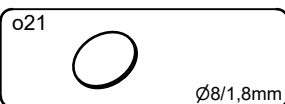

2x

